



HALLMARK HOMES

**P.O. BOX 1810
Charlestown, RI 02813
www.hallmarkmodularhomes.com
401-364-0400**

Product Information Guide

May 29, 2007

Contents

Housewrap	3
Siding	4
Shutters.....	9
Shingles	10
Entry Doors	12
Door Bells	15
Andersen Windows	16
Interior Doors and Trim	26
Flooring	34
Light Fixtures	38
Fireplace Surround.....	41
Cabinets and Vanities.....	46
Kitchen Sinks	47
Corian Options	48
Corian Colors	53
Formica	59
Range Hoods	61
Dishwashers	62
Faucets.....	65
Bath Fixtures	68
Pedestal Sink & Wall Mount Lavatory	76
Medicine Cabinets.....	77
Vanity Tops	78
Bath Fan/Lights.....	79
Toilets.....	80
Laundry Tubs	81
Ironing Center	82
Water Heaters.....	83
Reminders	84

*****Note: Hallmark Modular Homes reserves the right to substitute any products, parts and/or materials with goods of similar or greater value.**

*****Note: All Hallmark Modular Homes standard products are highlighted in yellow, or have a border around them. All other products are available at additional cost and extended delivery time may be involved**

Purpose of Housewrap

Housewrap serves as a dual-purpose weather barrier. It not only minimizes the flow of air in and out of a home, but also stops water and acts as a drainage plane. The unique characteristic of housewrap is that it allows water vapor to pass through it, while blocking liquid water. This permits moist, humid air to escape from the inside of the home, while preventing outside liquid water (i.e. rain) from entering the home.

When Should Housewrap Be Used?

Almost all exterior finishes allow at least some water penetration. If this water continually soaks the wall sheathing and framing members, problems such as dry rot and mold growth could occur. Housewrap stops water that passes through the siding and allows it to drain away from the structural members. In humid climates with heavy rainfall, housewrap is recommended to prevent water damage to the framing. Use in dryer climates may not be as critical, since materials are allowed to adequately dry. Housewrap also prevents air movement through the wall cavity, which is beneficial for insulating purposes.



We use Tyvek or equal housewrap.

CERTAINTEED MONOGRAM 46 SIDING

(4/4 Rough Cedar or 5/5 Dutchlap Rough Cedar):

Hallmark Modular Homes: Standard Siding & Color Choices

Colonial White, Sandstone Beige, Desert Tan, Savannah Wicker, Natural Clay, Cypress, Sterling Gray

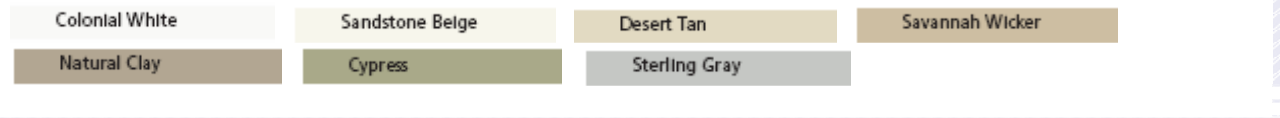

UPGRADE SOLID COLORS 4/4 Rough Cedar or 5/5 Dutchlap Rough Cedar:

Snow, Heritage Cream, Buckskin, Light Maple, Summer Wheat, Woodland Mist, Herringbone, Silver Ash, Oxford Blue, Granite Gray



UPGRADE DELUXE COLORS 4/4 Rough Cedar Only:

Barn Red, Ivy Green, Pacific Blue, Flagstone, Sable Brown



UPGRADE DELUXE BLEND COLORS 4/4 Rough Cedar or 5/5 Dutchlap Rough Cedar:

Canyon Blend, Glacier Blend, Meadow Blend



UPGRADE PREMIUM COLORS 4/4 Rough Cedar or 5/5 Dutchlap Rough Cedar:

Timber Blend, Frontier Blend, Weathered Blend, Artic Blend, Arbor Blend



*****SOME CURRENT COLORS HAVE BEEN OMITTED DUE TO SIDING LIMITATIONS AND/OR UNAVAILABILITY OF SIDING ACCESSORIES*****

Product Specifications

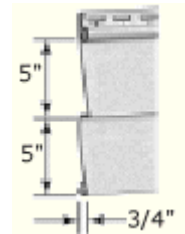
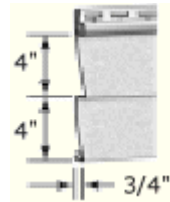
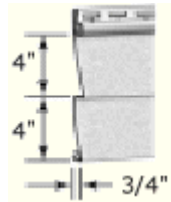

**Double 4" Clapboard
Solid Colors**

**Double 4" Clapboard
Blend Colors**

**Double 5" Clapboard
Solid Colors**

Finish

Rough Cedar

Rough Cedar

Rough Cedar

Panel Projection:

3/4"

3/4"

3/4"

Panel Length:

12'-6"

12'-6"

12'-6"

Thickness:

.046"

.046"

.046"

Product Code:

33110

33101

33122

Packaging:

Squares/carton:

2

2

2

Panels/carton:

24

24

20

Carton weight:

117 lbs. (approx.)

117 lbs. (approx.)

108 lbs. (approx.)

Product Specifications

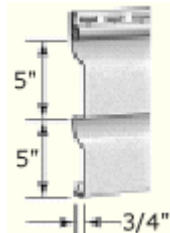
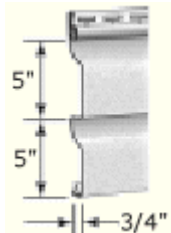

**Double 5" Dutchlap
Solid Colors**

**Double 5" Dutchlap
Blend Colors**

Finish

Rough Cedar

Rough Cedar

Panel Projection:

3/4"

3/4"

Panel Length:

12'

12'

Thickness:

.046"

.046"

Product Code:

33125

33103

Packaging:

Squares/carton:

2

2

Panels/carton:

20

20

Carton weight:

110 lbs. (approx.)

110 lbs. (approx.)

Color Matrix

	ARBOR BLEND	ARCTIC BLEND	AUTUMN YELLOW	BARN RED	BUCKSKIN	CANYON BLEND	COLONIAL WHITE	CYPRESS	DESERT TAN	FLAGSTONE	FRONTIER BLEND	GLACIER BLEND	GRANITE GRAY	HERITAGE CREAM	HERRINGBONE	IVY GREEN	LIGHT MAPLE	MEADOW BLEND	MUSKET BROWN	NATURAL CLAY	OXFORD BLUE	PACIFIC BLUE	SABLE BROWN	SANDSTONE BEIGE	SAVANNAH WICKER	SILVER ASH	SNOW	STERLING GRAY	SUMMER WHEAT	TIMBER BLEND	WARM SAND	WEATHERED BLEND	WOODLAND MIST		
SIDING PRODUCTS	57	50	10	25	41	69	01	42	07	97	51	67	34	11	04	28	55	68	49	60	32	27	29	15	59	38	31	33	76	52	09	53	77		
CEDAR IMPRESSIONS®																																			
D7" PERFECTION, D6-1/4" HALF-ROUND			•	•	•	•	•	•	•	•	•	•	•	•	•	•	•	•	•	•	•	•	•	•	•	•	•	•	•	•	•	•	•	•	
T5" PERFECTION			•	•	•	•	•	•	•	•	•	•	•	•	•	•	•	•	•	•	•	•	•	•	•	•	•	•	•	•	•	•	•	•	
D9" ROUGH-SPLIT SHAKES			•	•	•	•	•	•	•	•	•	•	•	•	•	•	•	•	•	•	•	•	•	•	•	•	•	•	•	•	•	•	•	•	•
CEDARBOARDS™																																			
D6", S7", D4", D4-1/2" DUTCHLAP							•	•	•				•	•						•	•			•	•		•	•							
MILLENNIUM®																																			
D4", D4-1/2" DUTCHLAP							•	•	•				•	•						•	•			•	•		•	•							
MONOGRAM™																																			
D4" ROUGH CEDAR	•	•	•	•	•	•	•	•	•	•	•	•	•	•	•	•	•	•	•	•	•	•	•	•	•	•	•	•	•	•	•	•	•	•	•
D5" ROUGH CEDAR							•	•	•				•	•						•	•			•	•		•	•							
D5" ROUGH CEDAR DUTCHLAP	•	•					•	•	•				•	•						•	•			•	•		•	•							
D4" BRUSHED							•	•					•	•						•	•			•	•		•	•							
MONOGRAM™ 46L																																			
D4", D5" DUTCHLAP							•	•	•				•	•						•	•			•	•		•	•							
BOARD & BATTEN																																			
SINGLE 8" VERTICAL							•	•	•				•	•						•	•			•	•		•	•							
CAROLINA BEADED™																																			
SINGLE 6-1/2"							•	•	•				•	•						•	•			•	•		•	•							
CLASSIC™																																			
D4", D5", D4-1/2" DUTCHLAP							•	•	•				•	•						•	•			•	•		•	•							
MAINSTREET™																																			
D4" WOODGRAIN			•				•	•	•				•	•						•	•			•	•		•	•							
D5", D4" & D5" DUTCHLAP WOODGRAIN							•	•	•				•	•						•	•			•	•		•	•							
6-1/2" BEADED, D4", T3" BRUSHED							•	•	•				•	•						•	•			•	•		•	•							
SINGLE 8" WOODGRAIN							•						•							•				•			•								
HAMILTON PARK®																																			
D4", D5", T3", D4-1/2" DUTCHLAP							•	•					•	•						•	•			•	•		•	•							
VINYL CARPENTRY™ SOFFIT & VERTICAL SIDING																																			
BEADED Soffit/Vertical																																			
T2" SOLID, T2" VENTED							•	•												•				•	•		•								
TRIPLE 3-1/3" Soffit/Vertical																																			
T3-1/2" SOLID AND INVISIVENT®							•	•	•				•	•						•				•	•		•	•							
IRONMAX™ Soffit/Vertical																																			
D5" SOLID, D5" VENTED	•	•					•	•	•	•	•	•	•	•	•	•	•	•	•	•	•	•	•	•	•	•	•	•	•	•	•	•	•	•	•
UNIVERSAL Soffit/Vertical																																			
T4" SOLID, T4" VENTED			•	•	•		•	•	•	•	•	•	•	•	•	•	•	•	•	•	•	•	•	•	•	•	•	•	•	•	•	•	•	•	•
T4" CENTER VENTED							•																				•								
VALUE Soffit																																			
T4" SOLID, T4" VENTED, T4" CENTER VENTED							•																				•								
D5" SOLID, D5" VENTED							•																				•								



Color performance, impact resistance and durability are assured through our exclusive PermaColor™ System, a blend of our own Certavin™ resin, superior micro-ingredients and state-of-the-art pigment chemistry.

	Double 4" Clapboard (rough cedar)	Double 4" Clapboard (brushed)	Double 5" Clapboard (rough cedar)	Double 5" Dutchlap (rough cedar)	Monogram 46L Double 4" Clapboard (rough cedar)	Monogram 46L Double 5" Dutchlap (rough cedar)	3/4" Outside Cornerpost	3-1/2" Lineal	5" Lineal
** Arbor Blend	●			●			●		
** Arctic Blend	●			●			●		
** Weathered Blend	●			●			●		
** Frontier Blend	●			●			●		
** Timber Blend	●			●			●		
* Canyon Blend	●			●			●		
* Meadow Blend	●			●			●		
* Glacier Blend	●			●			●		
* Sable Brown	●			●			●		
* Pacific Blue	●			●			●	●	
* Ivy Green	●			●			●	●	
* Barn Red	●			●			●		
* Flagstone	●			●			●		
Granite Gray	●	●	●	●	●	●	●	●	●
Oxford Blue	●	●	●	●	●	●	●	●	●
Cypress	●	●	●	●	●	●	●	●	●
Buckskin	●	●	●	●	●	●	●	●	●
Natural Clay	●	●	●	●	●	●	●	●	●
Savannah Wicker	●	●	●	●	●	●	●	●	●
Sterling Gray	●	●	●	●	●	●	●	●	●
Autumn Yellow	●						●		
Light Maple	●	●	●	●	●	●	●	●	●
Desert Tan	●	●	●	●	●	●	●	●	●
Woodland Mist	●	●	●	●	●	●	●	●	●
Silver Ash	●	●	●	●	●	●	●	●	●
Herringbone	●	●	●	●	●	●	●	●	●
Summer Wheat	●	●	●	●	●	●	●	●	●
Heritage Cream	●	●	●	●	●	●	●	●	●
Sandstone Belge	●	●	●	●	●	●	●	●	●
Snow	●	●	●	●	●	●	●	●	●
Colonial White	●	●	●	●	●	●	●	●	●

* DELUXE COLORS
 ** PREMIUM COLORS

NOTE: Colors are simulated. Consult product samples before final selection.

Monogram's palette of colors and variety of styles, finishes and trim, offer the widest range of design possibilities in the industry.

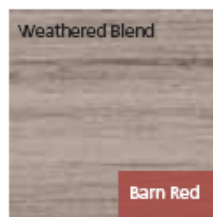
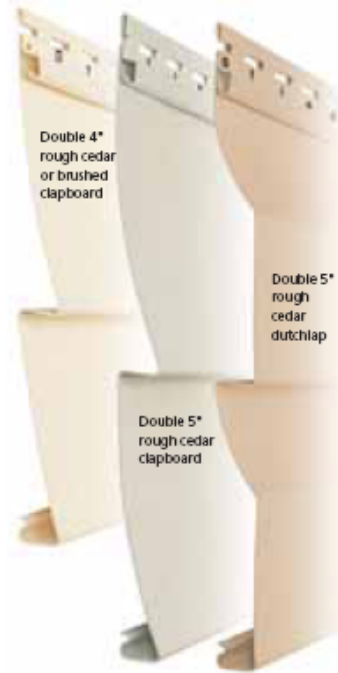

DISTINCT COLORS
 Choose one of Monogram's unique, darker hues or semi-transparent stained blend colors. And, you can select with confidence knowing that all of CertainTeed's colors are covered with PermaColor Lifetime Fade Protection.

Shutters: Panel or Louvered

Hallmark Modular Homes Standard Colors:

White, Red, Winestone, Green, Dark Spruce, Brown, Grey, Blue, Black, Navy, Pebblestone Clay

Upgrade Special Order Colors:

Spanish Moss, Blackwatch Green, Dark Berry, Copper

All special colors will incur additional stocking charges



Raised Panel



Louvered

Winestone color sample N/A Dark Berry color sample N/A Copper color sample N/A
White
Black
Blackwatch Green
Blue
Navy
Dark Spruce
Green
Grey
Brown
Pebblestone Clay
Red
Spanish Moss

Owens Corning Oakridge Pro 30 Architectural Shingles

Hallmark Modular Homes Standard Colors:

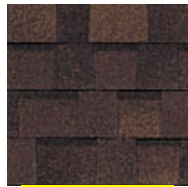

Brownwood

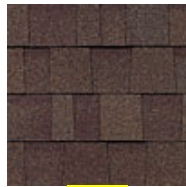

Teak

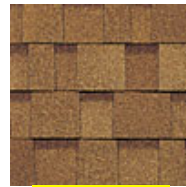

Desert Tan

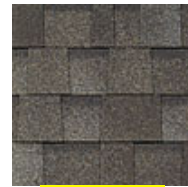

Driftwood



Onyx Black



Estate Gray



Sierra Gray

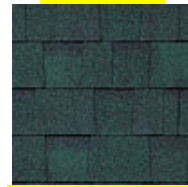

Chateau Green

Upgrade Colors Pro 30:

Amber, Quarry Gray, Harbor Blue, Colonial Slate, Slatestone Gray (available in zone 1 and 2)

Product Specifications

Nominal Size: 13 1/4" x 38 3/4"
 Exposure: 5 5/8"
 Shingles per Square: 66
 Bundles per Square: 3
 Coverage per Square: 99.9 sq. ft.

Upgrade Colors



Amber



Quarry Gray

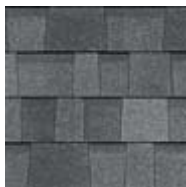

Slatestone Gray

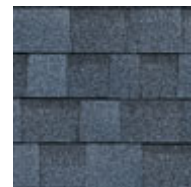

Harbor Blue

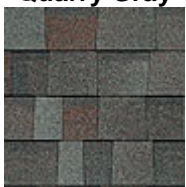

Colonial Slate



**Terra Cotta
(Pro 40 and 50 Only)**

Upgrade Colors Pro 40:

Amber, Brownwood, Teak, Desert Tan, Driftwood, Onyx Black, Estate Gray, Sierra Gray, Quarry Gray, Harbor Blue, Chateau Green, Colonial Slate, Slatestone Gray (available in zone 1 and 2), Terra Cotta (not available in zone 1 and 2)

Product Specifications

Nominal Size: 13 1/4" x 39 3/8"
 Exposure: 5 5/8"
 Shingles per Square: 64
 Bundles per Square: 4
 Coverage per Square: 98.4 sq. ft.

Upgrade Colors Pro 50:

Amber, Brownwood, Teak, Desert Tan, Driftwood, Onyx Black, Estate Gray, Sierra Gray, Quarry Gray, Harbor Blue, Chateau Green, Colonial Slate, Terra Cotta, Slatestone Gray (available in zone 1 and 2)

Product Specifications

Nominal Size: 13 1/4" x 39 3/8"
 Exposure: 5 5/8"
 Shingles per Square: 64
 Bundles per Square: 4
 Coverage per Square: 98.4 sq. ft.

Hip & Ridge Shingles



Product Specifications

Pieces per Box: 32
 Lineal Coverage per Box: 21.3 ft.
 Nominal Size: 12" x 12"
 Exposure: 8"

Smooth-Star®

Get the look of fine painted wood and the strength of steel with a front door from our Smooth-Star Entry Door Collection. An excellent value in a fiberglass entry door, made of rugged compression-molded fiberglass with deep detailed panels that create beautiful shadows and contours on your door's surface.

This perfectly stylish, yet rugged fiberglass front door resists the dents and dings from day-to-day traffic, and will never rust or corrode.

Therma-Tru Smooth-Star Recessed Panel Entry Door

Clear Glass Styles



Hallmark Standard



Hallmark Standard

Clear Glass with Grilles

Clear glass doorlites are double-paned. Grille options include fixed grilles, removable grilles, or grilles sealed between the glass.

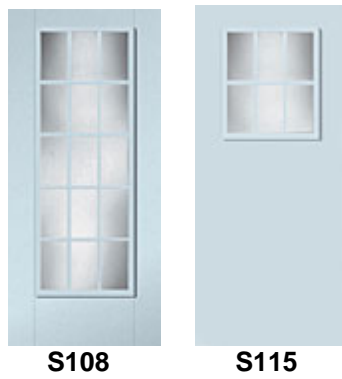



Transoms



Barcelona Handleset/Deadbolt

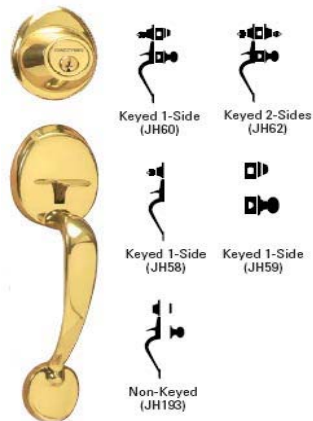

Standard Color – Satin Nickel (619)

Upgrade Colors: Bright Brass (605), Antique Brass (609), Antique Pewter (620), Bright Chrome (625), Satin Stainless Steel (630)



LA206WH

Contemporary wave design in bright white. Receiver mounts to wall or can be placed on table. Receiver powered by four "D" batteries (not included). Includes one button.

Dimensions: 6" x 7³/₈" x 2³/₄"





LA107WH

Classic vertical panel design in white. Molded plastic cover. Powered by a 16-volt transformer or four "D" batteries. Two-note chime for front door, single-note for second door.

Dimensions: 7³/₈" x 9" x 2³/₄"

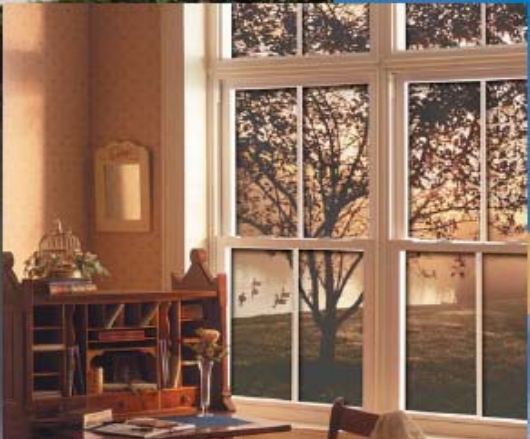
Standard- Series 3000 SilverLine Double Hung Window



Series 3000
New Construction Double Hung Window

SilverLine[®]
WINDOWS • DOORS 
an Andersen Company



Series 3000 New Construction Double Hung Window (Wood Sizing)

- 1 Heavy-duty fusion-welded vinyl construction creates a strong, weather-tight window, resulting in a rating of DP-50
 - 2 Standard 7/8" insulated glass with Intercept® Warm-Edge Spacer provides comfort and energy savings
 - 3 Integral brickmold 'J' channel type siding return provides for easy trimming of the exterior siding to the window
 - 4 Dual weatherstripping provides an energy efficient, weather-tight seal
- Continuous one-piece frame option provides a clean look, as well as easier handling and installation



Easy Installation: An integral nailing fin gets the Series 3000 into your opening quickly, while a 7/8" 'J' channel siding return allows fast and neat trimming of the exterior siding to the window. Optional wood extension jambs are available for 4-9/16" and 6-9/16" construction, along with a snap-in drywall return channel.

Sturdy Construction: Heavy-duty, fusion-welded vinyl construction creates a strong, weather-tight window. Twin and triple windows feature a continuous, one-piece frame, providing even greater strength, easier handling and faster installation.

Energy Efficient: Multi-chambered vinyl construction insulates as well as, or better than, other window materials. Several glazing options are available to provide comfort in virtually any climate. The Series 3000 is ENERGY STAR® qualified in all 50 states with optional LoE² Glass.

Attractive Look: A sturdy, continuous frame provides a virtually seamless appearance, and an attractive colonial profile gives the Series 3000 the look of detailed craftsmanship.

Proven Performance: Performance tested to stand up to extreme weather conditions. Certified to the specifications established by the American Architectural Manufacturers Association (AAMA).

Also available as an Impact Resistant Window



Limited Lifetime Warranty

Extension Jamb

An interior access channel allows the use of three different extension jamba: 4-9/16" for 2 x 4 construction, and 6-9/16" for 2 x 6 construction. A snap-in return for drywall applications allows for fast installation and a clean, professionally finished job.



Geometric Shapes

Including geometric shapes and picture windows will enhance the other window designs in your home, while giving it a unique style, adding light from new refreshing angles, and bringing natural comfort to your surroundings.



Design Flexibility

Our complete product line of double hungs, picture windows, transoms and geometric shapes can be combined in numerous ways. With so many window styles and sizes available, the design possibilities are virtually endless. Silver Line's® mulling systems feature strong, durable mullions, allowing you to mull and stack windows in numerous configurations.

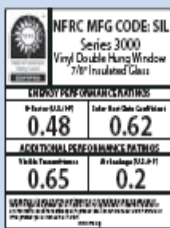
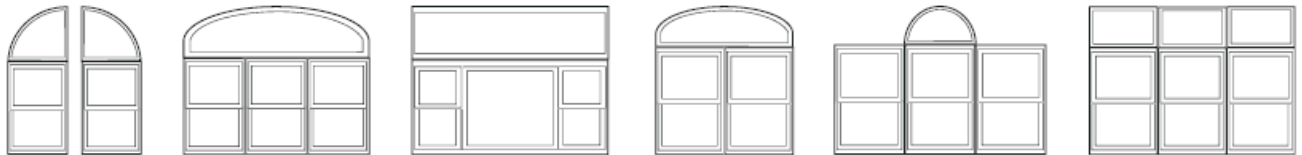

The NFRC label provides the U-Factor and Solar Heat Gain Coefficient ratings of a window. The lower the U-Factor, the more you'll save on heating bills. A low SHGC rating will help save on cooling costs.

The Series 3000 Double Hung Window has been tested and certified to NFRC standards for energy efficiency.

Glass Type	U-Factor	SHGC
Clear	0.48	0.62
LoE ²	0.35	0.32
LoE ² /Argon	0.31	0.32



AAMA is a nationally recognized authority, developing voluntary standards to test and validate the structural performance of windows, doors and skylights.

The Series 3000 has been tested and certified to AAMA design pressure (DP) standards. The higher the DP rating, the stronger the window.

Window Size	DP-Rating
34" x 65"	DP-50
38" x 65"	DP-45
108" x 77"	DP-35

Series 3000

State-of-the-art window technology is hard at work providing durable, energy efficient performance in low maintenance vinyl construction.

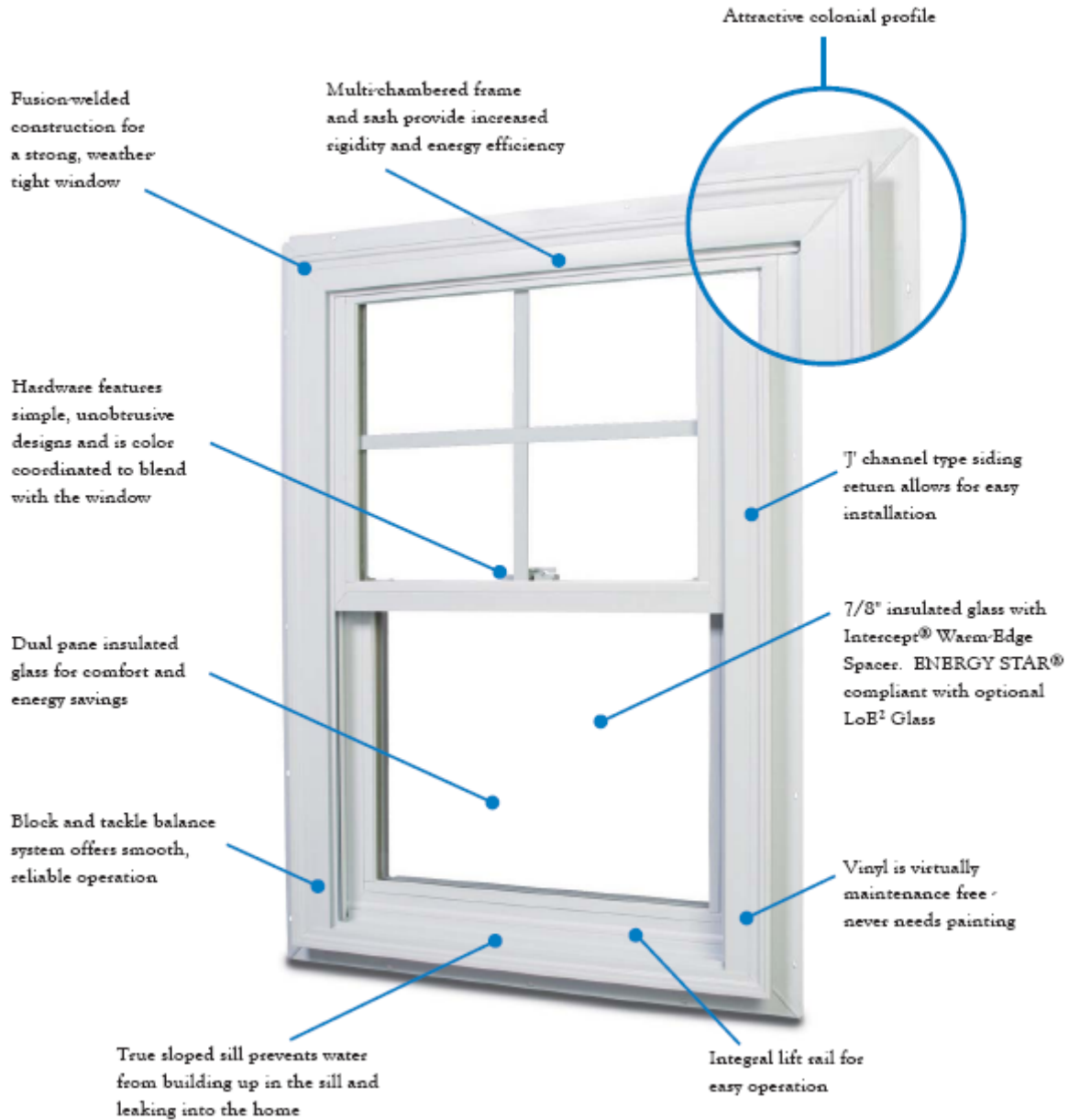

Series 3000 New Construction Double Hung Window Sizes - Nominal, Actual and Rough Opening Sizes

Nominal Size	1/8	2/0	2/4	2/8	3/0	3/4	3/8
Unit Dimension	21 3/4"	25 3/4"	29 3/4"	33 3/4"	37 3/4"	41 3/4"	45 3/4"
Rough Opening	22 1/4"	26 1/4"	30 1/4"	34 1/4"	38 1/4"	42 1/4"	46 1/4"
2/10 36 3/4" 37 3/4"							
3/2 40 1/4" 41 1/4"							
3/10 48 3/4" 49 3/4"							
4/2 52 3/4" 53 3/4"							
4/6 56 3/4" 57 1/4"							
5/2 64 3/4" 65 1/4"							
5/6 68 3/4" 69 1/4"							
6/2 76 3/4" 77 1/4"							

NOTES:

- clear opening of 5.7 sq. ft. or greater
clear opening width of 20" or greater
clear opening height of 24" or greater
- Unit dimension is inside frame dimension, not including nailing fin
- Window elevations are shown with optional grille patterns. Grille patterns shown are standard grille patterns for appropriate window sizes
- 5/6 height windows also available as "cottage style" windows (unequal sash). Top sash is shorter than the bottom sash
- 6/2 height windows also available as "oriel style" windows (unequal sash). Bottom sash is shorter than the top sash



Continuous, One-Piece Frame

Twin, triple and combination windows are offered with a continuous, one-piece frame and common intermediate jamb(s). This provides a more attractive window, that is easier to handle and install. The continuous frame feature also reduces labor by eliminating the mulling of separate windows at the job site.

Glass Options

Silver Line® offers several types of glass for just about any requirement. From energy savings, to sound control, to privacy, one of our many choices is sure to meet your needs.

Energy Saver LoE² Glass - Reduces heating and cooling costs while keeping your home more comfortable all year long. Also reduces fading to window treatments, furniture and floor coverings caused by harmful UV rays.



Other Glass Choices Include:

- Tempered Glass
- Tinted Glass
- Obscure Glass
- Laminated Glass
- LoE² Glass/Argon Gas

Grille Options

Maintenance Free Grilles - Grilles are sealed inside the glass unit, providing the look of muntins without the difficulty of cleaning them. Choose from two different grille types: flat or contour grilles. Several grille patterns are available, including Colonial, Prairie and Diamond.

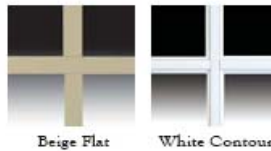

Colonial



Prairie



Diamond

Color Options

All Silver Line vinyl windows are available in white and beige. The color is consistent throughout the vinyl window frame and sash, making scratches virtually invisible.



White



Beige

For color matching purposes, request a color chip. Colors reproduced as closely as printing will allow.



Andersen

400 Series Tilt-Wash Double-Hung Window

- New High-Performance™ Low-E4™ glass stays cleaner, reduces water spotting up to 99% and cuts energy bills up to 25%
- Traditional style
- Rich natural wood interior
- Attractive low-maintenance exteriors
- Convenient tilt-in cleaning
- Wide range of sizes
- Variety of grilles & insect screen options

Frames, Finishes & Colors

Interior Finishes



Pine



White

Exterior Colors



Sandtone



White

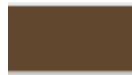

Terratone



Forest Green

Classic Series™

Hardware



Lock & Keeper



Traditional



Contemporary



Finger Lift

Finishes



White



Stone

Estate Series™

Hardware



Lock & Keeper



Traditional Sash Lift

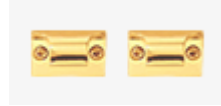

Finger Lifts

Finishes



Bright Brass



Antique Brass



Brushed Chrome



Oil Rubbed Bronze

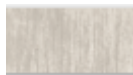

Satin Nickel



Distressed Bronze



Distressed Nickel



Polished Chrome

Glass Options

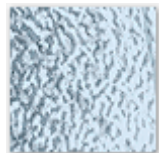

Obscure



Pebble



Cascade



Fern



Reed

Note: Pattern glass is available in both High-Performance™ Low-E and High-Performance™ Sun™ Low-E Glass options.

High-Performance™ Low-E4™ Tempered Glass

Stays cleaner, reduces water spotting up to 99% and cuts energy bills up to 25%. Tempered for additional safety.

High-Performance™ Low-E4™ Glass

Stays cleaner, reduces water spotting up to 99% and cuts energy bills up to 25%.



High-Performance Sun™ Low-E4™ Tempered Glass

Stays cleaner, reduces water spotting up to 99% and cuts energy bills up to 25%. Tempered for additional safety.

High-Performance Sun™ Low-E4™ Glass

Stays cleaner, reduces water spotting up to 99% and cuts energy bills up to 25%.



Grille Options

Hallmark Standard:



Finelight™ Grilles are installed between glass panes



Removable Interior Grilles



Removable Interior Grilles with Permanent Exterior Grilles



Permanent Exterior and Permanent Interior



Permanent Exterior and Permanent Interior with Spacer

**Finelight grilles only available in colonial pattern.

**Removable interior grilles are not available in pine.

Grille Finishes & Colors

Interior Finishes



Exterior Colors



Screen Types

Perma-Clean® Full Insect Screen

Ventilates through the entire window.

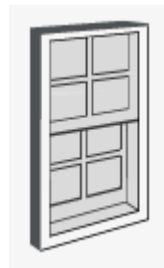

Combination Unit

Combines Perma-Clean® insect screen with a storm panel.

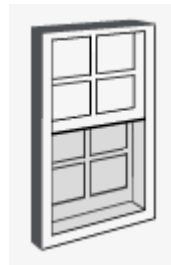

Screen Frame Colors



Interior Doors and Trim

GET THE DOOR THAT ENDURES

- Offers consistent quality throughout the home
- Engineered wood designs outperform wood doors while offering superior value
- Resists cracking, splitting, shrinking and joint separation
- Long-lasting with low maintenance
- Make doors a more profitable upgrade by offering the full CraftMaster line



Made from molded high-density fiberboard, CraftMaster doors resist shrinking, swelling, cracking and joint separation. Engineered wood design outperforms wood doors while offering superior value.

SPECIFY THE DOOR THAT MAKES THE GRADE

- Tested for water resistance, adhesion and overall durability to ensure product quality
- CraftMaster doors can be specified in 1 3/8" and 1 3/4" thicknesses
- All 1 3/4" thick CraftMaster doors can be manufactured to meet 20- and 60- minute fire ratings as per Warnock Hersey specifications

MAKE A SOLID CHOICE

- For the heft and sound-deadening properties of solid wood, specify solid core construction
- CraftMaster doors are available with solid core construction

EASY ON THE OUTSIDE

No old growth timber is harvested for the manufacture of CraftMaster designs. Instead, by-products from sawmill operations are used to convert wood chip waste into a design of true beauty.

TOUGH ON THE INSIDE

CraftMaster products are manufactured using advanced molded panel technology, wood fiber, and environmentally safe resins to create precisely engineered wood products that perform better than solid wood counterparts. A CraftMaster door facing is made from an engineered wood fiber mat that is molded under intense heat and pressure into an 1/8" (3.2mm) thick sheet of high-density fiberboard. The result assures consistent quality from door to door, room to room, home to home.

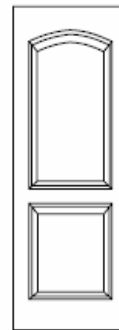

CAIMAN®

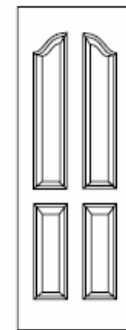

CARMELLE®

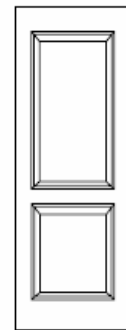

CARRARA®

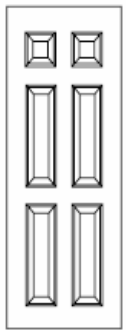

COLONIST®

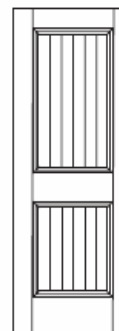

CORVADO™

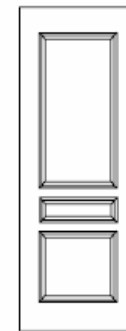

CLERMONT®

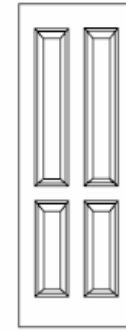

COVENTRY®

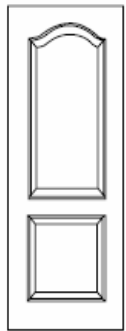

CLASSIQUE®
CREMONA®

Colonist Textured -Standard (Colonist smooth is an upgrade.)

COLONIST®

Pine woodgrain texture or smooth finish.

- Precision craftsmanship and more than a quarter century of market and design leadership distinguish the original and authentic Colonist from imitations.
- This classic design dresses up any room.
- Available in standard 6'8", 7'0", and 8'0" passage and bifold sizes.

COLONIST® FINISHED WHITE

Pine wood grain texture.

Hallmark Modular Homes Standard Door



PRE-STAINED

Pine woodgrain texture

Available in standard 6'8" passage and bifold sizes.

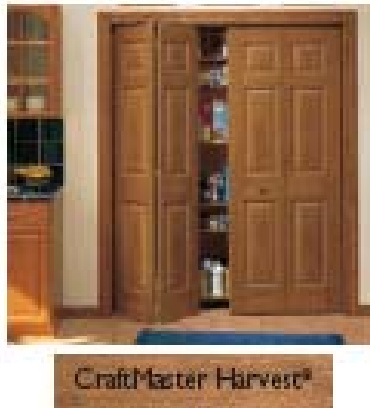

Due to the use of a protective topcoat sealer, pre-stained and finished white door designs cannot be repainted without fully removing the topcoat sealer.

Interior Door Upgrades:



CLASSIQUE®

Oak woodgrain texture.

CREMONA®

Smooth Finish.

- A distinctive look for any interior.
- Classique is available in standard 6'8" passage and bifold sizes. Cremona is available in standard 6'8", 7'0" and 8'0" passage and bifold sizes.

Also available:
CLASSIQUE® FINISHED WHITE
Oak wood grain texture.



CORVADO™

Smooth finish

- Two-panel, square-top plank interior door.
- Classic Shaker style in a smooth surface design.
- Distinctive groove and a modified sticking profile offer the rich feel of a traditional plank door, but with added detail.
- Available in standard 6'8" and 7'0" passage and bifold sizes.



CAIMAN®

Smooth Finish.

- Two panel, true arch design adds understated elegance to any décor.
- Available in standard 6'8", 7'0" and 8'0" passage and bifold sizes.



CARMELLE®

Oak woodgrain texture.

- Arched tops add interest to this four-panel classic.
- Available in standard 6'8" passage and bifold sizes.



CARMELLE® FINISHED WHITE
Oak wood grain texture.



CLERMONT®

Oak woodgrain texture.

- A simple, straightforward design that stands the test of time.
- Available in standard 6'8" passage and bifold sizes.



COVENTRY®

Oak woodgrain texture or smooth finish.

- The classic design adds charm and character to any room.
- Smooth finish available in standard 6'8", 7'0" and 8'0" passage and bifold sizes.
Textured finish available in 6'8" passage and bifold sizes.

SIZING OPTIONS

available

Pre-stained colors

in Colonist textured:

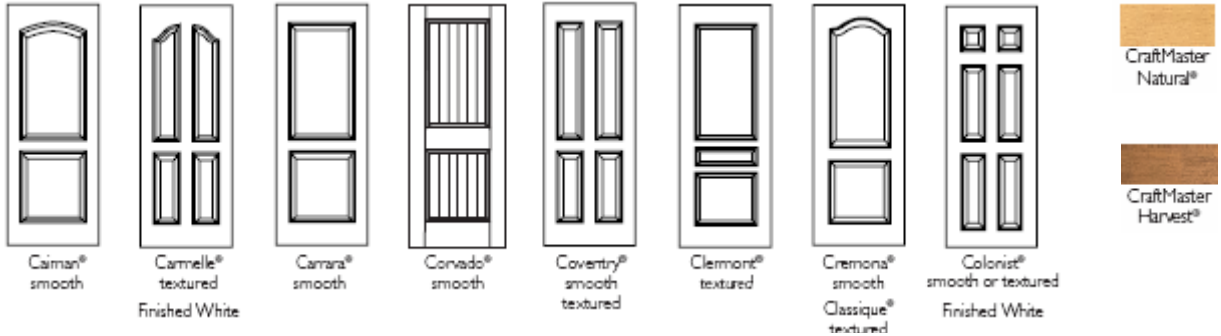

P A S S A G E

	1'0"	1'2"	1'3"	1'4"	1'6"	1'8"	2'0"	2'2"	2'4"	2'6"	2'8"	2'10"	3'0"	1'6"	B	F	O	L	D	S																																
CAIMAN [®] Smooth	✓	✓	✓	✓	✓	✓	✓	✓	✓	✓	✓	✓	✓		✓		✓	*	✓	✓	✓	✓	✓	✓	✓	✓	✓	✓	✓	✓	✓	✓	✓	✓	✓	✓	✓	✓														
CAIMAN [®] Smooth 7'	✓	✓	✓	✓	✓	✓	✓	✓	✓	✓	✓	✓	✓		✓		✓	*	✓	✓	✓	✓	✓	✓	✓	✓	✓	✓	✓	✓	✓	✓	✓	✓	✓	✓	✓	✓	✓	✓												
CAIMAN [®] Smooth 8'					✓	✓	✓	✓	✓	✓	✓	✓	✓			*	*	*	*	*	*	*	*	*	*	*	*	*	*	*	*	*	*	*	*	*	*	*	*													
CARMELLE [®] Textured				✓	✓		✓	✓	✓	✓	✓	✓	✓		✓	✓	✓	✓	✓	✓	✓	✓	✓	✓	✓	✓	✓	✓	✓	✓	✓	✓	✓	✓	✓	✓	✓	✓	✓	✓												
CARRARA [®] Smooth	✓	✓	✓	✓	✓	✓	✓	✓	✓	✓	✓	✓	✓		✓	✓	✓	✓	✓	✓	✓	✓	✓	✓	✓	✓	✓	✓	✓	✓	✓	✓	✓	✓	✓	✓	✓	✓	✓	✓	✓	✓										
CARRARA [®] Smooth 7'	✓	✓	✓	✓	✓	✓	✓	✓	✓	✓	✓	✓	✓		✓	✓	✓	✓	✓	✓	✓	✓	✓	✓	✓	✓	✓	✓	✓	✓	✓	✓	✓	✓	✓	✓	✓	✓	✓	✓	✓	✓	✓									
CARRARA [®] Smooth 8'	✓	✓	✓	✓	✓	✓	✓	✓	✓	✓	✓	✓	✓		✓	✓	✓	✓	✓	✓	✓	✓	✓	✓	✓	✓	✓	✓	✓	✓	✓	✓	✓	✓	✓	✓	✓	✓	✓	✓	✓	✓	✓									
CLERMONT [®] Textured	✓	✓	✓	✓	✓	✓	✓	✓	✓	✓	✓	✓	✓		✓		✓	✓	✓	✓	✓	✓	✓	✓	✓	✓	✓	✓	✓	✓	✓	✓	✓	✓	✓	✓	✓	✓	✓	✓	✓	✓	✓									
COLONIST [®] Textured	✓	✓	✓	✓	✓	✓	✓	✓	✓	✓	✓	✓	✓	✓	✓	✓	✓	✓	✓	✓	✓	✓	✓	✓	✓	✓	✓	✓	✓	✓	✓	✓	✓	✓	✓	✓	✓	✓	✓	✓	✓	✓	✓									
COLONIST [®] Smooth	✓	✓	✓	✓	✓	✓	✓	✓	✓	✓	✓	✓	✓		✓	✓	✓	✓	✓	✓	✓	✓	✓	✓	✓	✓	✓	✓	✓	✓	✓	✓	✓	✓	✓	✓	✓	✓	✓	✓	✓	✓	✓	✓								
COLONIST [®] Textured 7'							✓	✓	✓	✓	✓	✓	✓		✓	✓	✓	✓	✓	✓	✓	✓	✓	✓	✓	✓	✓	✓	✓	✓	✓	✓	✓	✓	✓	✓	✓	✓	✓	✓	✓	✓	✓									
COLONIST [®] Smooth 7'						✓	✓	✓	✓	✓	✓	✓	✓		✓	✓	✓	✓	✓	✓	✓	✓	✓	✓	✓	✓	✓	✓	✓	✓	✓	✓	✓	✓	✓	✓	✓	✓	✓	✓	✓	✓	✓	✓								
COLONIST [®] Textured 8'							✓	✓	✓	✓	✓	✓	✓		✓	✓	✓	✓	✓	✓	✓	✓	✓	✓	✓	✓	✓	✓	✓	✓	✓	✓	✓	✓	✓	✓	✓	✓	✓	✓	✓	✓	✓	✓								
COLONIST [®] Smooth 8'	✓	✓	✓	✓	✓	✓	✓	✓	✓	✓	✓	✓	✓		✓	✓	✓	✓	✓	✓	✓	✓	✓	✓	✓	✓	✓	✓	✓	✓	✓	✓	✓	✓	✓	✓	✓	✓	✓	✓	✓	✓	✓	✓	✓							
CORVADO [®] Smooth	✓	✓	✓	✓	✓	✓	✓	✓	✓	✓	✓	✓	✓		✓	✓	✓	✓	✓	✓	✓	✓	✓	✓	✓	✓	✓	✓	✓	✓	✓	✓	✓	✓	✓	✓	✓	✓	✓	✓	✓	✓	✓	✓	✓	✓						
CLASSIQUE [®] Textured	✓	✓	✓	✓	✓	✓	✓	✓	✓	✓	✓	✓	✓		✓	✓	✓	✓	✓	✓	✓	✓	✓	✓	✓	✓	✓	✓	✓	✓	✓	✓	✓	✓	✓	✓	✓	✓	✓	✓	✓	✓	✓	✓	✓	✓	✓					
CREMONA [®] Smooth					✓	✓	✓	✓	✓	✓	✓	✓	✓		✓		✓	*	✓	✓	✓	✓	✓	✓	✓	✓	✓	✓	✓	✓	✓	✓	✓	✓	✓	✓	✓	✓	✓	✓	✓	✓	✓	✓	✓							
CREMONA [®] Smooth 7'					✓	✓	✓	✓	✓	✓	✓	✓	✓		✓		✓	*	✓	✓	✓	✓	✓	✓	✓	✓	✓	✓	✓	✓	✓	✓	✓	✓	✓	✓	✓	✓	✓	✓	✓	✓	✓	✓	✓	✓						
CREMONA [®] Smooth 8'	✓	✓	✓	✓	✓	✓	✓	✓	✓	✓	✓	✓	✓		*	*	*	*	*	*	*	*	*	*	*	*	*	*	*	*	*	*	*	*	*	*	*	*	*	*	*	*	*	*	*	*						
COVENTRY [®] Textured	✓	✓	✓	✓	✓	✓	✓	✓	✓	✓	✓	✓	✓		✓	✓	✓	✓	✓	✓	✓	✓	✓	✓	✓	✓	✓	✓	✓	✓	✓	✓	✓	✓	✓	✓	✓	✓	✓	✓	✓	✓	✓	✓	✓	✓	✓					
COVENTRY [®] Smooth	✓	✓	✓	✓	✓	✓	✓	✓	✓	✓	✓	✓	✓		✓	✓	✓	✓	✓	✓	✓	✓	✓	✓	✓	✓	✓	✓	✓	✓	✓	✓	✓	✓	✓	✓	✓	✓	✓	✓	✓	✓	✓	✓	✓	✓	✓	✓				
COVENTRY [®] Smooth 7'	✓	✓	✓	✓	✓	✓	✓	✓	✓	✓	✓	✓	✓		✓	✓	✓	✓	✓	✓	✓	✓	✓	✓	✓	✓	✓	✓	✓	✓	✓	✓	✓	✓	✓	✓	✓	✓	✓	✓	✓	✓	✓	✓	✓	✓	✓	✓	✓			
COVENTRY [®] Smooth 8'	✓	✓	✓	✓	✓	✓	✓	✓	✓	✓	✓	✓	✓		✓	✓	✓	✓	✓	✓	✓	✓	✓	✓	✓	✓	✓	✓	✓	✓	✓	✓	✓	✓	✓	✓	✓	✓	✓	✓	✓	✓	✓	✓	✓	✓	✓	✓	✓			
COLONIST [®] COMMERCIAL Smooth														✓																																						
COLONIST [®] COMMERCIAL Smooth 7'														✓																																						
COLONIST [®] Finished White Textured	✓	✓	✓	✓	✓	✓	✓	✓	✓	✓	✓	✓	✓		✓	✓	✓	✓	✓	✓	✓	✓	✓	✓	✓	✓	✓	✓	✓	✓	✓	✓	✓	✓	✓	✓	✓	✓	✓	✓	✓	✓	✓	✓	✓	✓	✓	✓	✓	✓		
CARMELLE [®] Finished White Textured				✓	✓		✓	✓	✓	✓	✓	✓	✓		✓	✓	✓	✓	✓	✓	✓	✓	✓	✓	✓	✓	✓	✓	✓	✓	✓	✓	✓	✓	✓	✓	✓	✓	✓	✓	✓	✓	✓	✓	✓	✓	✓	✓	✓	✓		
CLASSIQUE [®] Finished White Textured					✓	✓	✓	✓	✓	✓	✓	✓	✓		✓		✓																																			
CRAFTMASTER PRESTAINED Textured**	✓	✓	✓	✓	✓	✓	✓	✓	✓	✓	✓	✓	✓		✓	✓	✓	✓	✓	✓	✓	✓	✓	✓	✓	✓	✓	✓	✓	✓	✓	✓	✓	✓	✓	✓	✓	✓	✓	✓	✓	✓	✓	✓	✓	✓	✓	✓	✓	✓		
REFLECTION SERIES Textured							✓	✓	✓	✓	✓	✓	✓																																							
CAIMAN [®] CELLINI Smooth 6'8", 7'	✓	✓	✓	✓	✓	✓	✓	✓	✓	✓	✓	✓	✓																																							
CARRARA [®] CELLINI Smooth 6'8", 7'	✓	✓	✓	✓	✓	✓	✓	✓	✓	✓	✓	✓	✓																																							

* Check with your door manufacturer for fit/did availability. We recommend recess doors for these applications.

Standard Color-Satin Nickel (619)

Upgrade Colors: Bright Brass (605), Antique Brass (609), Antique Pewter (620), Bright Chrome (625), Satin Stainless Steel (630)

Corona Knob

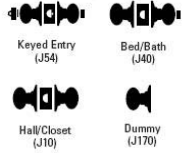

Torino Lever

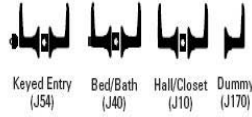

Barcelona Handleset/Deadbolt

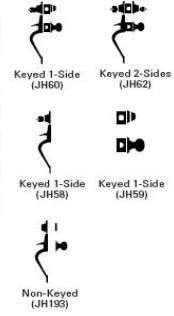

Standard Trim—366 Casing 2 1/4", 623 Base 3 1/4"

Colors:



Natural
(Light)



Harvest
(Medium)



White



HH366
Colonial Feather Edge Casing
1 11/16" x 2 1/4"



HH623
Colonial Base
1 7/32" x 3 1/4"

Upgrade Options:



HH217
Early American Casing
1 1/16" x 3 9/16"



HH445
Colonial Bead Casing
3/4" x 3 1/4"



HH297
Chair Rail
3/4" x 3"



HH163E
Lamb's Tongue Base
5/8" x 5 1/4"



**HH53
Crown
11/16" x 2 5/8"**



**HH49
Crown
11/16" x 3 1/2"**



**47
Crown
11/16" x 4 5/8"**

Flooring: Can be factory installed as an option in areas which do not cross the mating walls. Ask your Hallmark Representative for details.

****VINYL SHEETING IS NOT AVAILABLE****

Sovereign Tile: 12" x 24"



(PT11)
Almond Travertine



(PT12)
Ivory Travertine



(PT24)
Dover Slate



(PT21)
River Slate

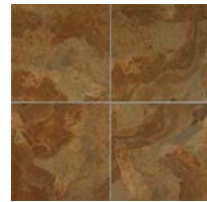

(PT22)
Canyon Slate

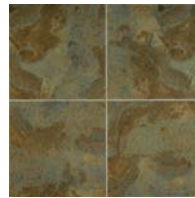

(PT23)**UPGRADE
Mountain Slate

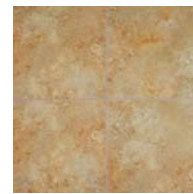

(PT13)**UPGRADE
Walnut Travertine

Alloc Original Plank Tile 3/8"



(138711)
Sevilla Pearl



(138712)
Barcelona Beige

12” Daltille Ceramic Floor

Gold Rush:

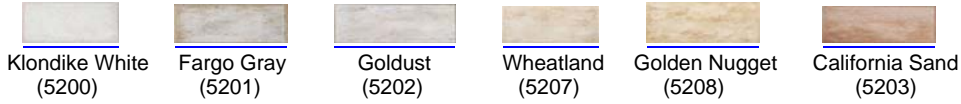

Ridgeview:

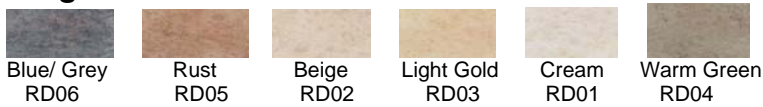

Village Bend:



Passaggio:



12” Daltille Stone Slate

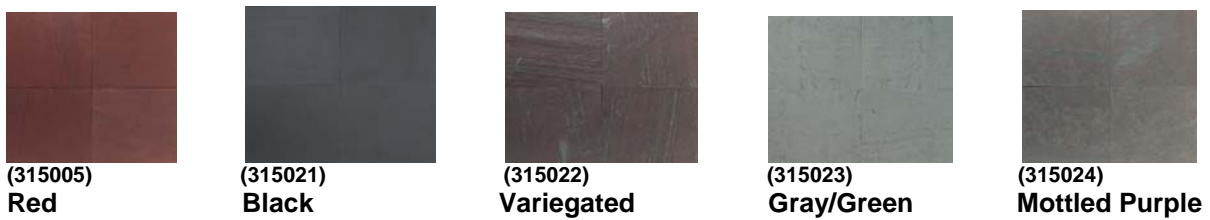

Alloc Hardwood 3/8”











CENTURY FLOORING

Solid Prefinished Oak Flooring

All our Solid Prefinished Oak grades have planks that are 3/4" thick and come in random 1' - 6-1/2' lengths.

(2 1/4"—18.25 SQ. FT. per CTN. / 3 1/4"—17.6 SQ. FT. per CTN. / 52 # per CARTON)





Width Grade								
2-1/4"	Elite	SG	SG S	SG S	SG S	SG S	SG S	SG S
	Builder's Choice	SG	SG S	SG S	SG S	SG S	SG S	
	Antique			S		S	S	S
3-1/4"	Elite	SG	SG S	SG S	SG S	SG S	SG S	SG S
	Builder's Choice	SG	SG S	SG S	SG S	SG S	SG S	
	Antique			S		S	S	S

 = Semi-Gloss Finish (65 Gloss)
 = Satin Finish (35 Gloss)

Solid Prefinished Maple & Birch Flooring

All our Solid Prefinished Maple and Birch grades have planks that are 3/4" thick and come in random 1' - 6-1/2' lengths.

(20 SQ. FT. per CTN. / 56 # per CARTON)

Width Grade							
2-1/4"	Elite	SG	SG	SG	SG	SG	SG
	Builder's Choice		SG	SG			
3-1/4"	Elite	SG	SG	SG	SG	SG	SG
	Builder's Choice		SG	SG			

 = Semi-Gloss Finish (65 Gloss)



HALLMARK MODULAR HOMES & SHAW CARPET STYLE AND COLORS 2007

Materials shipped loose –ask your Hallmark Representative for details.

SEDONA 185SC 13'7 & 186SC 15'3 25 OZ. SAXONY

- | | |
|--------------------|----------------------|
| ■ 47608 Blueberry | ■ 40851 Merino Wool |
| ■ 33340 Botanical | ■ 57704 Pebble |
| ■ 02204 Cappuccino | ■ 57100 Praline |
| ■ 57804 Cordovan | ■ 41156 Stone |
| ■ 08003 Fawn | ■ 05229 Summer Straw |

TRANSITIONS 236SC 13'7 & 237SC 15'3 38 OZ. TEXTURED SOLID COLORS

TRANSITIONS 238SC 13'7 & 239 SC 15'3 BERBER COLOR

TRANSITIONS 240SC 13'7 & 241SC 15'3 JEWEL COLORS

SOLID COLORS

- 41042 Tumbleweed
- 71756 Bourbon
- 71754 Sandstone
- 71752 Gazelle
- 41039 Meadow
- 41030 Oyster
- 71460 Denim
- 82500 Urban Putty
- 71154 Classic Taupe
- 37216 Seaweed

JEWEL COLORS

- 00110 Symphony
- 00310 Encore
- 00510 Timpani
- 00710 Cello
- 00711 Allegro

BERBER COLOR

- 41012 Flax

SHOWCASE TA658 13'7 & TB658 15'3 45 OUNCE SAXONY

- | | |
|---------------------|--------------------|
| 16113 Oak Ash | 40182 Desert Beige |
| 31558 Eelskin | 13107 Beeswax |
| 85407 Sable | 15109 Silkworm |
| 31557 Gentry Taupe | 31686 Kiwi |
| 68714 Scarlet | 36216 Green Meadow |
| 32823 Vanilla | 40186 Taupe Beige |
| 31559 Face Powder | 31560 Albany Smoke |
| 65605 Copper Wire | 31555 Fedora Grey |
| 76702 Sisal | 43405 Chambray |
| 78703 Mineral Brown | 31550 Regal Blue |

CREATIVE 208SC 13' & 209SC 15' 40 OZ. BERBER

- 15100 Porcelain
- 15101 Rocky Road
- 15200 Hint of Honey
- 15300 Sage
- 15500 Marble
- 15700 Cinnamon Stick
- 15701 Espresso
- 15702 Brazil Nut

Standard Lighting Fixtures

Standard Color-Brushed Nickel



77063-962

Hall/Utility/Walk-in-closet

Single Light Brushed Nickel Finish Close to Ceiling Fixture with Satin White Glass
 Diameter: 10 ½" Height: 5 ¾"
 1-Medium Base 100 W
 Max 120 Volts
 Lamp Bulb (not included)



77064-962

Kitchen/Bedroom

Two Light Brushed Nickel Close to Ceiling Fixture with Satin White Glass
 Diameter: 12 ½" Height: 6 ¼"
 2-Medium Base 60 W Max
 120 Volts
 Lamp Bulbs (not included)



77065-962

Three Light Brushed Nickel Close to Ceiling Fixture with Satin White Glass
 Diameter: 14 ½" Height: 7"
 3-Medium Base 60 W Max
 120 Volts
 Lamp Bulbs (not included)



7504-02

****Optional—Polished Brass**

Single light close to ceiling fixture w/satin white glass.
 UL listed for Dry Locations
 Diameter: 11 ½" Height: 6 ¼"
 1-Med. A-Line 100w max
 Lamp Bulb (not included)



7505-02

****Optional—Polished Brass**

Two light close to ceiling fixture w/satin white glass.
 UL listed for Dry Locations
 Diameter: 12 ¾" Height: 6 ¼"
 2-Med. A-Line 60w max
 Lamp Bulbs (not included)



7506-02

****Optional—Polished Brass**

Three light close to ceiling fixture w/satin white glass.
 UL listed for Dry Locations
 Diameter: 14 ¾" Height: 6 ¾"
 3-Med. A-Line 60w max
 Lamp Bulbs (not included)



Vanity-2 Light

44019-962

Brushed Nickel Finish / Satin White Glass
 Width: 12" Height: 8" Extends: 7 ½"
 Height from center of outlet box: 2 ¾"
 2-Medium Base 100 W Max
 120 Volts
 Lamp Bulbs (not included)



4871-05

Chrome-optional

Vanity-2 Light

(Chrome/Brass option)

Clear ribbed glass
 Width: 13 ¼" Height: 7 ¾" Extends: 7 ½"
 Height from center of outlet box: 3"
 2-Medium Base 100 W Max
 (Bulbs not included)



4871-02

Polished Brass-optional



Vanity-3 Light

44020-962
 Brushed Nickel Finish / Satin White Glass
 Width: 12" Height: 8"
 Height from center of outlet box: 3"
 3-Medium Base 100 W Max 120
 Volts Lamp Bulbs (not included)



4872-05
Chrome-optional

Vanity-3 Light

(Chrome/Brass option)
 Width: 17" Height: 6 ½"
 Height from center of outlet box: 3"
 3-Medium Base 100 W Max
 120 Volts
 Lamp Bulbs (not included)



4872-02
Polished Brass-optional



Vanity-4 Light

44021-962
 Brushed Nickel Finish / Satin White Glass
 Width: 23 ½" Height: 8" Extends: 8"
 Height from center of outlet box: 2 ¾"
 4-Medium Base 100 W Max
 120 Volt Lamp Bulbs (not included)



4873-05
Chrome-optional

Vanity-4 Light

(Chrome/Brass option)
 Width: 20 ½" Height: 7 ¼" Extends: 8"
 Height from center of outlet box: 3"
 4-Medium Base 100 W Max
 120 Volt Lamp Bulbs (not included)



4873-02
Polished Brass-optional



6641-962



6641-02

Polished Brass-optional**Nook**

Brushed Nickel / Clear Plastic Shade

Diameter: 16 ¼" Height: 11" Overall: 61"

1 Medium Base 100 W Max

120 Volts

Lamp Bulbs (not included)



8038-965



8038-02

Polished Brass-optional**Exterior Coach**

Antique Brushed Nickel / Clear Curved Beveled Glass

Width: 8" Height: 12" Extends: 7 ¾"

Height from center of outlet box: 4 ½"

1-Medium Base 100 W Max 120 Volts Lamp Bulb (not included)

Fireplaces

Color Availability for Marble Surround on Fireplace:



Pale Gray/White/Onyx



White/Timberland/Onyx



White/White/Onyx



Bone/White/Onyx

Color Sample N/A
Sea Green Granite



Steel Gray Granite



White/Black/Onyx

Color Sample N/A
Coal Granite

Color Sample N/A
Ecru Granite

Color Sample N/A
White/Biscuit/Onyx



Sand Granite



Terra Cotta Granite

Color Sample N/A
White/Verde Green/Onyx

***The wood surround pictured below is not included with the marble surround, see pages 42-44 to choose an optional wood surround.*



Sea Green Granite Surround



White/Timberland Onyx Surround



Steel Gray Surround



Pale Gray/White Onyx Surround

Hallmark Modular Homes Optional Wood Fireplace Surrounds:

Available Colors: Raw Oak, Raw Pine, White Finish, Natural (light) Stain, & Harvest (medium) Stain



GRANT



GARFIELD



HAYES



LINCOLN



ARTHUR



ADAM



JACKSON



MADISON



FILLMORE



HARRISON



JEFFERSON



MCKINLEY



MONROE



POLK



TAYLOR



VANBUREN



ROOSEVELT



TYLER



WASHINGTON

Stone Surround

Color availability: Carnoustie, Pennsylvania, West Chester, and Sedona

Profile availability: Fieldstone / Drystack



Carnoustie Fieldstone



Pennsylvania Drystack

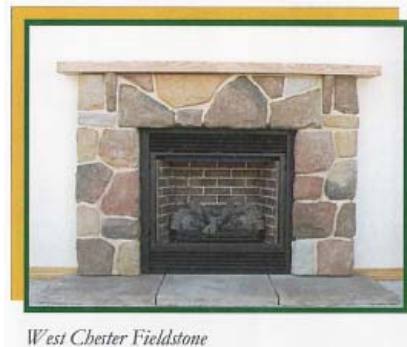

West Chester Fieldstone

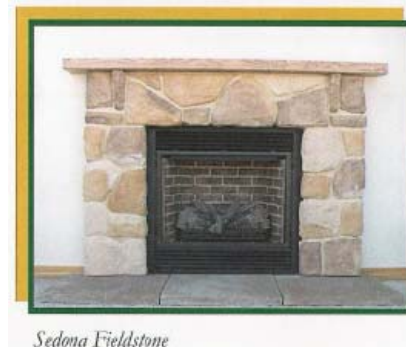

Sedona Fieldstone

Brick and Wood Surround



Tile with Wood Surround



****All fireplace surrounds are available with or without a raised hearth.**

****For available Martin Fireplace model numbers please see the literature in the builder sample kit.**

Some choices would be: Woodburning, Direct Vent and Vent Free in Natural or LP Gas.

****Builders please address the location of the vent cap and / or the chimney chase along with the on-site finishing options.**

Merillat Cabinets & Vanities:

Standard: Seneca Ridge Oak Square Raised Panel

Standard Colors: Natural, Cider, Medium

UPGRADE TO ARCH WALL CABINETS:

COLORS: Natural, Cider, Medium

UPGRADE TO MAPLE:

COLORS: Sable, Natural, Toffee

UPGRADE TO CHERRY:

COLORS: Cider, Paprika



finishes:  **OAK**



finishes:  **MAPLE**



finishes:  **CHERRY**

*****Please refer to the January 2007 Merillat Classic Product Specification Catalog (page 147) for more details on the upgraded products & color availability.*****

*****Hardware is not available through Hallmark Modular Homes.**

Kitchen Sinks



Moenstone #25425W
 Double Bowl Sink
 Colors:



Ivory



Glacier



Black



Moen #22823
 4 Hole Sink
 Bowl Size:
 7.5" x 16" x 5.5"
 21" x 16" x 6.38"



Moen #22355
 Single Bowl Undermount
 Bowl Size: 21" x 16" x 8"



Camelot #22245 Bar Sink
 13"L x 17"W Sink
 Includes 4901 bar faucet and 2" Sealtite strainer drain assembly
 Heavy 20 gauge thick stainless steel
 Fully undercoated for sound deadening and condensation control
 Has 2 holes for faucet



Moen #3910
 Liquid Soap & Lotion Dispenser
 Top lifts off for easy refill



Double Bowl
 33" x 22"
FHP Model #DS804BX



Moen #4901
 Bar Faucet
 Lever handle
 2.2 gpm (8.3 L/min) max.



Corian® Small Sinks

Corian® single sinks are compact yet functional. Use one by itself, or in combination with other Corian® sinks. Sinks are available in a number of colors to complement any design.



Corian® Large Sinks

For spacious styling, a large, single Corian® sink is a popular choice. Select one to use alone or in any sink combination.



Corian® Double Sinks

Double the sink means double the workspace. And these models go beyond practical, with a contemporary style and elegance to complement your design.



Corian® Bathroom Sinks

Corian® bathroom sinks provide beauty, functionality, durability, stain resistance and easy care through years of use. And because Corian® is nonporous, it won't promote the growth of mold or mildew. A variety of colors and styles will inspire your creative side.

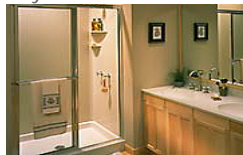

Corian® Tubs and Showers

When you're looking for fast, easy installation, here's your answer: Corian® Ready-To-Install Tub and Shower Surrounds. You can even install them over sound, existing tile. There's no grout to scrub, which makes for easy care. A semi-gloss finish reduces visible water spotting, while curved corners eliminate hard-to-clean crevices. Convenient shelves hold soap and shampoo.



Corian® Vanity Tops & Bowls

An integral covered backsplash and a thick front edge treatment provide a custom look in models made to fit more than 30 standard cabinet sizes. Recessed faucet decks catch and guide water overflow back into the bowl. And vanity tops flow seamlessly into bowls, eliminating trapped dirt and germs.

#810 Corian Single Bowl Sink



Colors:

-  Bisque
-  Cameo White
-  Glacier White
-  Natural Pearl
-  Vanilla

Top View

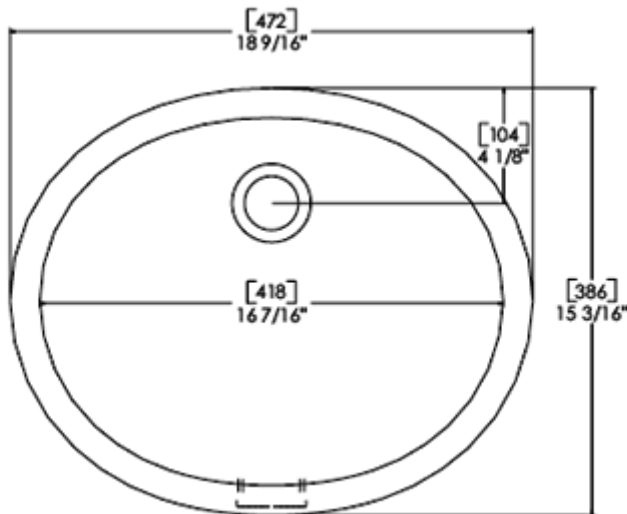

Side Cross-Section

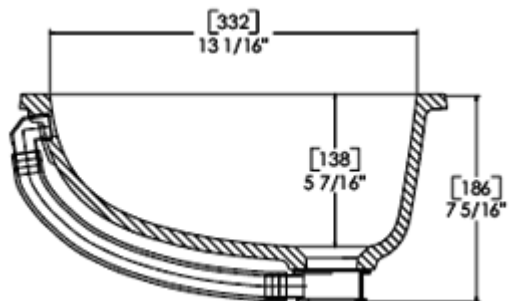

All drain holes are nominally 1 3/4" (45mm) in diameter and accept all standard drain hardware, including waste disposal units. Metric conversions are approximate.

#871 Corian Single Bowl Sink



Colors:

-  Bisque
-  Cameo White
-  Glacier White
-  Natural Pearl
-  Vanilla

Top View

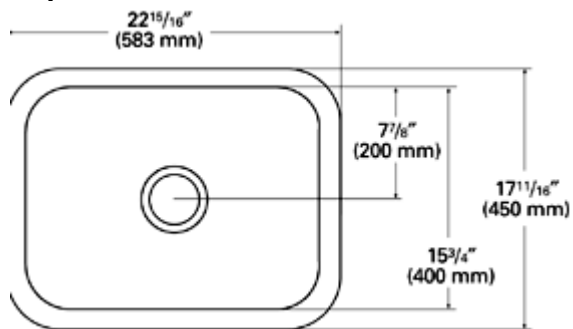

Front Cross-Section

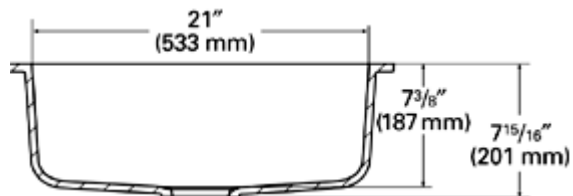

#850 Corian Double Bowl Sink



Colors:

-  Bisque
-  Cameo White
-  Glacier White
-  Natural Pearl
-  Vanilla

Top View

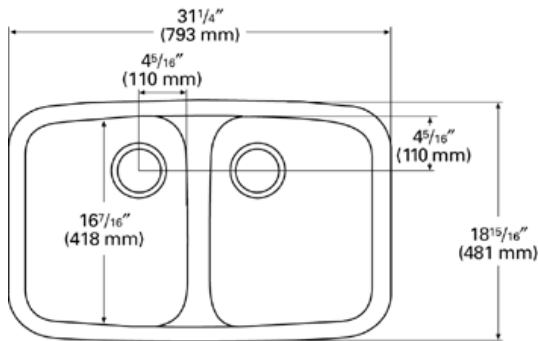

Front Cross-Section

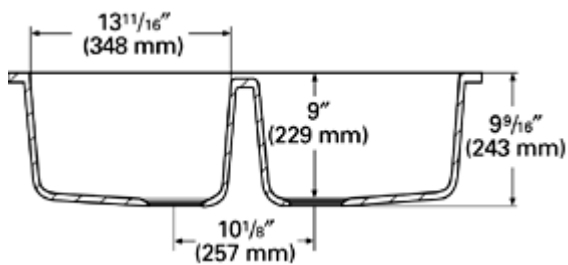

Corian® countertops in bisque with an 850 sink in bisque.



Corian® counters in black quartz with a two-sink installation in cameo white.

Corian Vanity Tops

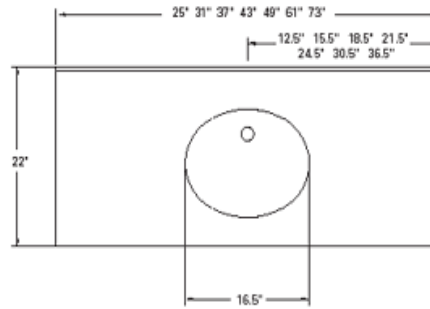

TOP VIEW

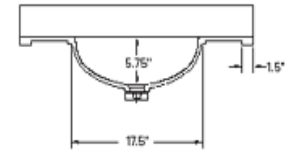

FRONT CROSS-SECTION

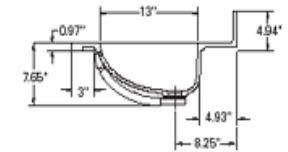

SIDE CROSS-SECTION

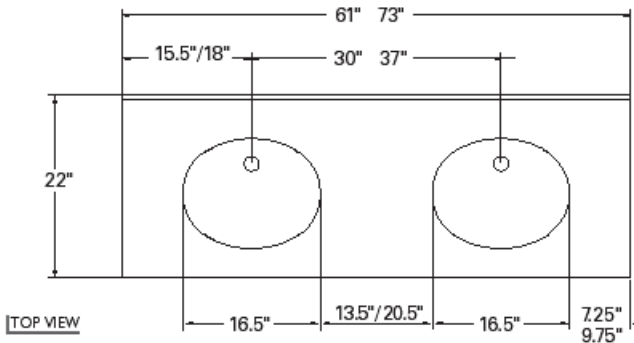

TOP VIEW

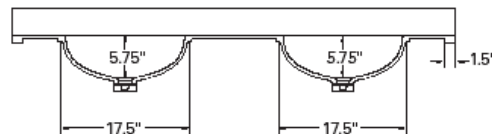

FRONT CROSS-SECTION

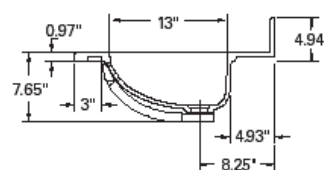

SIDE CROSS-SECTION

Most Popular Colors

An upgraded solid surface countertop is available in the following profiles: 433 Ogee edge, 211 Bevel edge, Single round over edge, and Double round over edge



Glacier White



Savannah



Aurora



Sahara



Everest



Mojave



Sandstone



Matterhorn



Linen



Burnt Amber



Silt



Maui



Pepper Ivory



Gray Fieldstone



Tumbleweed



Dusk



Willow



Mont Blanc

Note: Rounded countertop corners on an island or peninsula will have a minimum radius of 3”.

Colors for Corian Inlay

Note: Rounded corners can be done on Formica tops with solid surface inlay edge profiles.



Glacier White



Malachite



Everest



Aurora



Dusk



Evergreen

Note: Solid surface material (Corian, etc.) is not an option for upgraded backsplash edging. The backsplash is too narrow to accept inlay.

Colors for Bath Bowls & Kitchen Sinks



Bisque



Cameo White



Glacier White



Natural Pearl



Vanilla

Other Colors

Extra Lights

Extra Lights, each with its own character, are the most traditional and universal as they combine well with all other colors and materials.



Glacier White



White Jasmine*



Antarctica



Everest



Whitecap



Venaro White



Cameo White



Dawn Beige



Bone



Linen



Bisque



Rice Paper*



Vanilla



Festival

Beiges

The subtle tone-on-tone depths found in each color/texture define this palette, providing a distinctive, rich quality.



Abalone



Savannah



Tumbled Glass



Aurora



Fossil



Beige Fieldstone



Canvas*



Sahara



Butter Cream



Mojave



Delta Sand



Raffia



Beach



Kilimanjaro

Naturals

The richness of nature, both essential and genuine, inspire this sophisticated and timeless palette.



Pepper Ivory



Oyster



Seashell



Sandstone



Ochre



Eclipse



Matterhorn



Burnt Amber



Acorn



Doeskin



Silt



Canyon



Cocoa Brown



Shale



Maui

Warm

A palette of warmth and softness, from comforting creamy beige to the rich and satisfying terra-cotta and earth browns.



Peach



Primrose



Sequoia



Terra



Adobe



Rosetta



Ruby



Pompeii Red

Yellow Greens

A fresh, luminous palette of colors/textures ranging from light to dark, pale to saturated.



Pyrenees



Tarragon



Caribbean



Olive



Willow



Prairie



Moss

Greens

Dramatic, yet calming, this palette can be easily combined with neutral colors and materials.



Seagrass



Beach Glass



Spruce



Malachite



Green Tea*



Rain Forest



Evergreen

Blues

Fusions of sky and water to stimulate creativity and create unique spaces and sensations.



Blue Pebble



Aqua



Blue Ridge



Turkish Blue



Stone Washed



Storm Blue



Oceanic



Atlantis



Mediterranean



Azure



Cobalt



Flint

Grays

Neutral and monochromatic colors/textures that combine well with traditional materials.



Dusk



Platinum



Mont Blanc



Pearl Gray



Dove



Gray Fieldstone



Macadam

Extra Darks

Fundamentally deep color values for sophistication and elegance with subtle differences between colors/textures.



Midnight



Black Quartz



Night Sky



Nocturne



Mardi Gras



Blackberry Ice



Gravel



Bronze Patina



Anthracite

Brights

Soft, simple yet energetic for use where the spirit of spontaneity and a stimulating effect is desired.



Sun



Mandarin



Hot



Lilac



Graphic Blue

Private Collection

Artisan Series



Tumbleweed **new!**



Sagebrush **new!**



Chamois



Verde



Slate



Aubergine

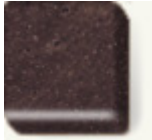

Earth **new!**

Palladio Series



Cirrus White



Ecru



Camel



Natural Gray

New in 2005

Concrete, Fawn, Serene Sage, Suede, Tranquil and Whisper – the six new Corian® Colors – reflect the simplicity and quiet beauty of nature. Each subtle hue is designed to work as either an understated background or focal point of your ideal interior space.



Concrete



Fawn



Serene Sage



Suede













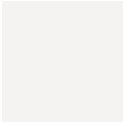

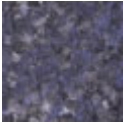





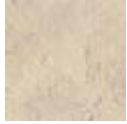

Tranquil



Whisper

Note: Occasionally Montelli or Pinnacle products are substituted for Corian products, we will make every effort to ensure that you are aware of any changes.

Formica Countertop Standard Colors *(smooth finish)*

				
300-58 Sail White Oxide	949-58 White	3517-58 Sand Crystal	3525-58 Azul Granite	3526-58 Travertine
				
3687-58 Autumn Indian Slate	3688-58 Madras Indian Slate	3690-58 Basalt Slate	3917-58 Rosso Granite	7022-58 Natural Canvas
				
7217-58 Arctic Terra	7219-58 Forest Terra	7263-58 Indigo Terra	7264-58 Lime Stone	7495-58 Pebble Envision
				
7694-58 Sky Terra	7732-58 Butterum Granite	7733-58 Ubatuba Granite	7735-58 Portico Marble	7736-58 Tuscan Marble
				
7734-58 Jamocho Granite	3692-58 Labrador Granite	3522-58 Perlato Granite		

Upgrade Formica Etchings *(textured finish)*

Sand Crystal 3517-46, Travertine 3526-46, Azul Granite 3525-46, Rosso Granite 3917-46, Ubatuba Granite 7733-46, Portico Marble 7735-46, Tuscan Marble 7736-46, Blackstone 271-46, Blk Faux Marble 754-46, Flint Crystal 3518-46, Silica Quartzline 3519-46, Baltic Granite 3691-46, Bottlegreen Quartzlite 3520-46, Lava Quartzlite 3521-46, Giallo Granite 3523-46

Profile 677 with Formica bevel (standard)

Upgrade Profiles:

Profile 677 with a different color bevel edge

Profile 100 Square Edge

Profile 211 with Oak, Maple, Cherry or Solid Surface Bevel

Profile 433 with Oak, Maple, Cherry or Solid Surface Ogee Edge

Post-Form

Note: Formica countertop edge upgrades do not include the backsplash. The backsplash will have a square edge. For an additional charge a wood edge profile or a Formica bevel edge can be added to the backsplash, however, solid surface material (Corian, etc.) is not an option for backsplash edging.

Rounded corners are available on Formica tops with wood edge profiles and solid surface edge profiles (Corian, etc.). The countertop rounded corner minimum radius is 3". Clipped (angled) corners must be used instead of rounded corners on Formica tops with a Formica bevel.

Post formed countertops are not recommended since repairs are difficult if not impossible and any damage usually involves replacement of the entire countertop.

Wilsonart Premium Laminate Colors *(textured finish)*



Deepstar Bronze

1814-35

Premium Laminate

The warmth of burnished bronze and old gold blended together for a mid-value sophisticated neutral.



Deepstar Jade

1816-35

Premium Laminate

Tones of green from slate, foliage, and gems, combine to form an oasis of color. Hints of old and new balanced in a fresh interpretation.



Deepstar Slate

1818-35

Premium Laminate

Shadowed hues of deep blues and browns are combined to create this organic black.



Deepstar Mineral

1817-35

Premium Laminate

A blend of sienna, copper, and rust, this bittersweet combination is reflective of the unexpected color and complexity of sedimentary rock, and its organic influences.



Deepstar Glaze

1813-35

Premium Laminate

This neutralized combination of gold, brown, and beige offer a sense of familiarity in softened tones, essential to the category.



Deepstar Flint

1811-35

Premium Laminate

Blue is transformed into an organic feel with the incorporation of taupes and brown to neutralize it.



Deepstar Agate

1815-35

Premium Laminate

Deep Khaki and aged bronze hues mixed with iron and ore to recreate the rustic interpretation of age-old and timeless materials.



Deepstar Fossil

1812-35

Premium Laminate

Mid-tone warmth of amber and orange is shadowed with deep charcoal and sienna to reflect the unexpected surprise of nature's ability to offer strength in color.

Range Hood- Allure I

Standard- 30" (QS130)

Upgrade-36" or 42" (QS136/QS14)

Standard Colors—White, Biscuit, Almond, Black, and Stainless Steel



Quiet 1.5 Sones at normal speed, 220 CFM high setting.

Fully enclosed design for easy cleaning. Standard large filters, dishwasher safe. Two-level light setting; dual halogen lamp design. **Bulbs not included.**

Two-speed contoured rocker switch control.

The quietest range hood in it's category, with the revolutionary performance and the brilliance of halogen lighting.

DISHWASHERS



GE Nautilus™ Built-In Dishwasher.....(GSD3200JWW)

Model#: GSD3200J

Available in: white (WW), stainless steel (GSD3260JSS), bisque (CC) or black (BB)

- Trimless Door Design — Features sleek, classic panels for an instant built-in look
- PowerScrub™ wash system — Cleans thoroughly with two wash arms
- HotStart™ Option — Preheats water before the main wash cycle for dependable performance every time
- Piranha™ Hard Food Disposer — Grinds leftover food into small particles that are easily washed away
- Deluxe Upper Rack — Includes a deep, tiered upper rack
- [QuietPower™ I Sound Package](#) — Softens the sound of the dishwasher, for a more peaceful kitchen



GE® Tall Tub Built-In Dishwasher.....(GLD4200MCC)

Model # GLD4200M

Available in: white (WW), stainless steel (GLD4260MSS), bisque (CC) or black (BB)

- Full-Length Flat Door — Blends almost seamlessly with adjacent cabinetry
- Giant Tub with Deluxe Capacity Racking — Washes up to 14 place settings at once
- HotStart™ Option — Preheats water before the main wash cycle for dependable performance every time
- 6-Level BrilliantClean™ Towerless Wash System — Quietly and efficiently powers dishes clean using remarkably less water and energy; 6 wash levels and three wash arms direct water onto dishes just where it's needed
- QuietPower™ 1 Sound Package — Runs quietly and effectively, with insulation that keeps sound sealed inside
- China/Crystal Cycle — Protects delicate dishes and glassware by lowering the water temperature during the cycle



GE® Built-In Dishwasher.....(GSD2200GBB)

Model#: GSD2200G

Available in: white (WW), bisque (CC) or black (BB)

- Trimless Door Design — Features sleek, classic panels for an instant built-in look
- QuietDesign™ sound package — Reduces washing noises with a blanket of insulation and the GE QuietPower™ motor
- [Deluxe Lower Rack](#) — Features curved tines to accommodate stoneware, large plates or broiler pans
- Deluxe Silverware Basket — Provides convenient space and capacity to clean silverware efficiently and effectively
- HotStart™ Option — Preheats water before the main wash cycle for dependable performance every time
- Heated Dry Option — Circulates warm air to quickly and gently dry dishes



GE® Tall Tub Built-In Dishwasher.....(GLD5500LWW)

Model#: GLD5500L

Available in: white (WW), stainless steel (GLD5560LSS), bisque (CC) or black (BB)

Giant Tub with Super Capacity Racking — Washes up to 15 place settings at once, with room for cookie sheets, platters and other tall items

Two Utility Shelves in Upper Rack, Silver — Flip down to provide an extra shelf for small items

SaniSensor™ — Continually measures water temperature to sanitize dishes

Electronic Controls with 5 Cycles/4 Options — Make it simple to select from a wide range of wash cycles

QuietPower™ 2 Sound Package — Keeps sound inside where it belongs, wrapping the dishwasher in a full blanket of insulation

2/4/8-Hour Delay Start — Makes it easier than ever to wash dishes at any hour taking advantage of reduced energy rates or washing dishes even when the family is asleep



GE® Tall Tub Built-In Dishwasher.....(GLD6500LBB)

Model#: GLD6500L

Available in: white (WW), stainless steel (GLD6560LSS), bisque (CC) or black (BB)

GE Giant Tub with Maximum Capacity Duron™ Racking — Washes even the largest cookware in durable, polymer-coated racks that will hold up to heavy use

Four Utility Shelves in Tiered Upper Rack with StemSafe™, Silver — Adds an extra level for stacking small items and allows for washing tall items in the upper and lower rack simultaneously

6-Level BrilliantClean™ Towerless Wash System with CleanSensor™ — Scrubs dishes clean with three full-sized wash arms, six levels of wash action and a sensor that continually monitors and adjusts the wash cycle for a superior clean

Light-Touch Electronic Controls with 6 Cycles/4 Options — Require only gentle pressure to start your preferred cycle; wipe clean easily

Countdown display with 1-9 hour Delay Start — Signals remaining cycle time and makes it easier than ever to wash dishes at any hour, taking advantage of reduced energy rates or washing dishes even when the family is asleep

QuietPower™ 3 Sound Package — Dramatically reduces the sound of washing the dishes



GE Profile™ Built-In Dishwasher(PDW7880JSS)

Model#: PDW7800J

Available in: stainless steel (PDW7880JSS), bisque (CC), white (WW) or black (BB)

[One-Piece Color Wrap Contour Door](#) — Provides a rich contemporary look in any kitchen

Nylon racks with color-matched components —

Holds tall and oversized items; washes 16 place settings at once

Four-Position Adjustable Upper Rack — Moves up, down and diagonally for maximum loading flexibility

100% Fold-down tines in lower rack — Provides maximum loading flexibility in the lower rack

QuietPower™ 4 Sound Package — Adds extra insulation to keep the kitchen extra quiet



GE® Tall Tub Built-In Dishwasher.....(GLD5500LBB)

Model#: GLD5500L

Available in: stainless steel (GLD5560LSS), bisque (CC), white (WW) or black (BB)

Washes up to 15 place settings at once, with room for cookie sheets, platters and other tall items
 Two Utility Shelves in Upper Rack, Silver — Flip down to provide an extra shelf for small items
 SaniSensor™ — Continually measures water temperature to sanitize dishes
 Electronic Controls with 5 Cycles/4 Options — Makes it simple to select from a wide range of wash cycles
 QuietPower™ 2 Sound Package — Keeps sound inside where it belongs, wrapping the dishwasher in a full blanket of insulation
 2/4/8-Hour Delay Start — Makes it easier than ever to wash dishes at any hour taking advantage of reduced energy rates or washing dishes even when the family is asleep



GE Nautilus™ Built-In Dishwasher.....(GSD3200JCC)

Model#: GSD3200J

Available in: white (WW), stainless steel (GSD3260JSS), bisque (CC) or black (BB)

Trimless Door Design — Features sleek, classic panels for an instant built-in look
 PowerScrub™ wash system — Cleans thoroughly with two wash arms
 HotStart™ Option — Preheats water before the main wash cycle for dependable performance every time
 Piranha™ Hard Food Disposer — Grinds leftover food into small particles that are easily washed away
 Deluxe Upper Rack — Includes a deep, tiered upper rack
[QuietPower™ I Sound Package](#) — Softens the sound of the dishwasher, for a more peaceful kitchen



GE® Built-In Dishwasher.....(GSD3900LWW)

Model#: GSD3900L

Available in: white (WW), stainless steel (GSD3960LSS), bisque (CC) or black (BB)

PowerScrub™ wash system — Cleans thoroughly with two wash arms
 Electronic Controls — Provide a smooth easy-to-use, easy-to-clean surface
 Hi-Temp Wash option — Allows detergent to work better so dishes come out clean
 QuietPower™ Sound Package — Softens the sound of the dishwasher for a more peaceful kitchen
 Deluxe Upper Rack — Allows easy loading of tall items
 Dual Filtration — Provides an extra level of filtration for cleaner wash water

Faucets

Product Specifications

Standard Faucet Color-Brushed Nickel



Brushed Nickel (standard)

K-10412

Forte® Single-Control Kitchen Sink Faucet with Escutcheon, Sidespray and Lever Handle

22" stainless steel braided flexible supply hoses

One-piece ceramic disc valve crushes and removes line debris for leak-free faucet

High-temperature limit stop allows you to preset a comfortable maximum temperature to eliminate scalding

3/8" fitting on hoses fastens directly to stops for faster hook-up

Solid metal construction ensures years of beauty

ADA-compliant



Chrome (optional)

K-15182-F

Kohler Coralais® Single-Control Centerset Lavatory Faucet with Lever Handle

Single-control handle meets ADA requirements

Kohler ceramic disc valves exceed industry longevity standards two times for a lifetime of durable performance

Solid brass construction for durability and reliability

KOHLER finishes resist corrosion and tarnishing, exceeding industry durability standards two times



K-300-K
1/2" Ceramic High-Flow Valve System



Brass (optional)

K-T15294-4
Coralais® Rim-Mount Bath Faucet Trim with
Lever Handles



K-304-K
Kohler Rite-Temp™ Pressure-Balancing Valve

Rite-Temp pressure-blocking valve prevents scalding and freezing
High-temperature limit stop allows you to preset a comfortable maximum temperature to eliminate scalding
Proven diaphragm design virtually eliminates freeze-ups from contamination and water debris



Chrome (optional)

Chrome (optional)

**K-T15611-4
Kohler Coralais® Shower Mixing Valve Faucet Trim with Lever Handle**

Single-control handle meets ADA requirements
Ergonomic lever handle for ease of operation
Trim only, requires valve to complete
All-metal construction ensures durability and long life
ADA-compliant

**K-T15601-4
Kohler Coralais® Bath and Shower Mixing Valve Faucet Trim with Lever Handle**

Single-control handle meets ADA requirements
Ergonomic lever handle for ease of operation
Trim only, requires valve to complete
All-metal construction ensures durability and longer life
NPT diverter spout
ADA-compliant

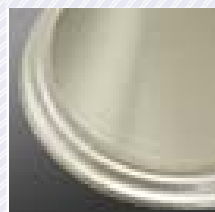

**Brushed Nickel
(standard)**



**Polished Chrome
(optional)**

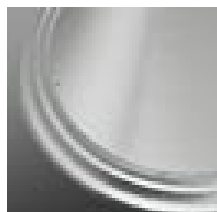

**Brushed Chrome
(optional)**

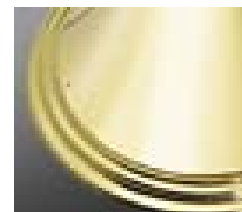

**Vibrant Polished Brass
(optional)**

Lasco Bath Fixtures

Standard Colors

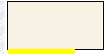

Bone



White

Upgrade Stock Colors



Almond

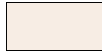

Biscuit

(Color Sample N/A)
Innocent Blush



Sterling Silver

(Color Sample N/A)
Linen

Note: Black is not available thru our normal supplier.



Model #: 1363-C
Dimensions:
36"W x 36"D x 72"H



Model #: 1382-NAC
Dimensions:
38"W x 38"D x 72"H



Model #: 1423-CBFS
Dimensions:
 45"W x 50-3/4"D x 77-7/8"H (ext.)



Model #: 1423-C
Dimensions:
 42"W x 34"D x 72"H



Model #: 1482-SNAC
Dimensions:
 48"W x 48"D x 76"H



Model #: 4836-BFS
Dimensions:
 53"W x 37"D x 84"H (ext.)
 48-1/2"W x 36"D x 81-5/16"H (int.)



Model #: 1483-OS
Dimensions:
 48"W x 33-1/2"D x 72"H



Model #: 1483-SG
Dimensions:
 48"W x 35"D x 72"H



Model #: 1543-CTN
Dimensions:
 54"W x 27-1/2"D x 72"H



Model #: 6036-CFS
Dimensions:
 65"W x 37"D x 83-3/4"H (ext.)
 60"W x 36"D x 79"H (int.)



Model #: 60ACTS
Dimensions:
 60"W x 34"D x 84"H



Model #: 6032-ITS
Dimensions:
 65"W x 33"D x 84"H (ext.)
 60"W x 32"D x 80-1/2"H (int.)



Model #: 1603-COS
Dimensions:
 60"W x 35"D x 72"H



Model #: 1603-SG
Dimensions:
 60"W x 35"D x 72"H



Model #: 1603-DTS
Dimensions:
 60"W x 36"D x 76"H



Model #: 2603-SG
Dimensions:
 60"W x 32"D x 72"H



Model #: 6036-HW
Dimensions:
 60"W x 36"D x 25"H



Model #: 7236-STWP
 (Also available as a soaking tub)
Dimensions:
 72"W x 36"D x 76"H



Alana I
Model #: 2660411
 (Also available as a soaking tub)
Dimensions:
 60"W x 42"D x 18-1/2"H



Alana II
Model #: 2760411
 (Also available as a soaking tub)
Dimensions:
 60"W x 42"D x 20-1/4"H



Alydar I
Model #: 5660621
 (Also available as a soaking tub)
Dimensions:
 60"W x 42"D x 23-7/8"H



Angelico
Model #: 797261
 (Also available as a soaking tub)
Dimensions:
 72"W x 36"D x 19"H



Ariel III
Model #: 3172621
 (Also available as a soaking tub)
Dimensions:
 72"W x 42"D x 23"H



Ascot II
Model #: 4466531
 (Also available as a soaking tub)
Dimensions:
 66"W x 34"D x 21-1/2"H
Shape: Decked Rectangular



Cetina II
Model #: 1872421
 (Also available as a soaking tub)
Dimensions:
 72"W x 36"D x 21-3/4"H
Shape: Decked Rectangular



Deauville
Model #: 4660621
 (Also available as a soaking tub)
Dimensions:
 60"W x 30"D x 21-1/2"H
Shape: Decked Rectangular



Delphinus
Model #: 1260641
 (Also available as a soaking tub)
Dimensions:
 60"W x 60"D x 22"H
Shape: Corner



Eden
Model #: 1072621
 (Also available as a soaking tub)
Dimensions:
 71-3/4"W x 47"D x 23-3/4"H



Gardenia III
Model #: 1160411
 (Available with greenboard or walls & shower)
 (Also available as a soaking tub)
Dimensions:
 60"W x 48"D x 27-3/4"H
Shape: Integrally Skirted



Giordanno II
Model #: 6572621
 (Available with greenboard)
 (Also available as a soaking tub)
Dimensions:
 72"W x 42"D x 23-1/2"H
Shape: Decked Hourglass



Jasmine I
Model #: 1760421
 (Available with greenboard)
 (Also available as a soaking tub)
Dimensions:
 60"W x 36-1/8"D x 21"H
Shape: Decked Rectangular



Kayla
Model #: 5160621
 (Available with greenboard)
 (Also available as a soaking tub)
Dimensions:
 60"W x 60"D x 22"H
Shape: Corner



Kohler – Drop in Tub
K-1184



Kohler – Soaker
K-1245



Model #: 2543-CTGN
Dimensions:
 60"W x 35"D x 72"H



Model #: 2600-30
 (Available with greenboard)
Dimensions:
 60"W x 30"D x 15"H



Model #: 2603-2P
Dimensions:
 60"W x 30"D x 72"H



Model #: 2603-CTS
Dimensions:
 60"W x 40-3/4"D x 72"H



Model #: 2603-CTWWP
Dimensions:
 60"W x 32"D x 72"H



Model #: 2603-OSN
Dimensions:
 60"W x 36"D x 15"H



Model #: 2720-SKWP
 (Available as a soaking tub)
Dimensions:
 72"W x 36"D x 20"H
Shape: Decked Rectangular



Model #: 6042-HWWP
 (Available as a soaking tub)
Dimensions:
 60"W x 42"D x 25"H
Shape: Integrally Skirted



Model #: 6042-STWCWP
 (Available as a soaking tub)
Dimensions:
 60"W x 42"D x 76"H
Shape: Tub/Shower



Model #: 6042-STWP
 (Available as a soaking tub)
Dimensions:
 60"W x 42"D x 74"H
Shape: Tub/Shower



Model #: 7236-STWP
 (Available as a soaking tub)
Dimensions:
 72"W x 36"D x 76"H
Shape: Tub/Shower



Model #: 4960621
 (Available as a soaking tub)
Dimensions:
 60"W x 41-1/2"D x 23-7/8"H
Shape: Oval



Octavia
Model #: 1372841
 (Available as a soaking tub)
Dimensions:
 72"W x 48"D x 23"H
Shape: Decked Rectangular



Pegasus
Model #: 2271621
 (Available as a soaking tub)
Dimensions:
 71"W x 47"D x 22-5/8"H
Shape: Decked Oval



Sylva
Model #: 2072621
 (Available as a soaking tub)
Dimensions:
 72"W x 47-9/16"D x 19-1/2"H
Shape: Decked Rectangular



Varsari
Model #: 6760621
 (Available as a soaking tub)
Dimensions:
 60"W x 42"D x 20-1/2"H
Shape: Decked Oval



Venus I
Model #: 460421
 (Available as a soaking tub)
Dimensions:
 60"W x 42"D x 21-3/4"H
Shape: Di-Oval



Venus II
Model #: 572421
 (Available as a soaking tub)
Dimensions:
 72"W x 44"D x 21-3/4"H
Shape: Di-Oval



Model #: 2603-TWWP
 (Available as a soaking tub)
Dimensions:
 60"W x 42"D x 26-1/4"H
Shape: Decked Oval



**Alcove
Single Threshold Shower Pan**

Model #: 3636-PAN
Dimensions: 36"W x 36"D x 6"H

Model #: 4234-PAN
Dimensions: 42"W x 34"D x 6"H

Model #: 4834-PAN
Dimensions: 48"W x 34"D x 6"H

Model #: 6034-PAN
Dimensions: 60"W x 34"D x 6"H



Model #: 2600-CBD
(Also available as a soaking tub)
Dimensions: 60"W x 60"D x 24-1/2"H
Shape: Integrally Skirted



Model #: 2600-CCS
(Also available as a soaking tub)
Dimensions: 60" W x 60"D x 21-1/2"H
Shape: Integrally Skirted

*****The 2600 Tub Series will only be available in the skirted, non-whirlpool version, the only available color is white.**

Pedestal Sink

Sink Top (4" centers)
Pedestal Leg

0115.404.222
731100.400.222



- white (020)
- bone (021)
- silver (165)
- shell (173)
- linen (222)

0355.012 4" CTRS FOR WALL HANGER OR CONCEALED ARMS

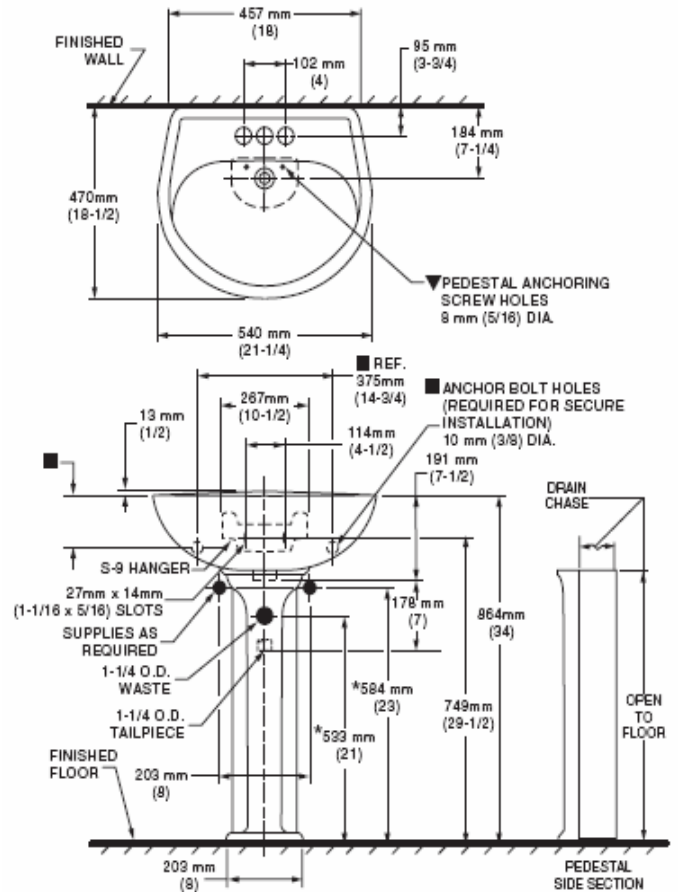
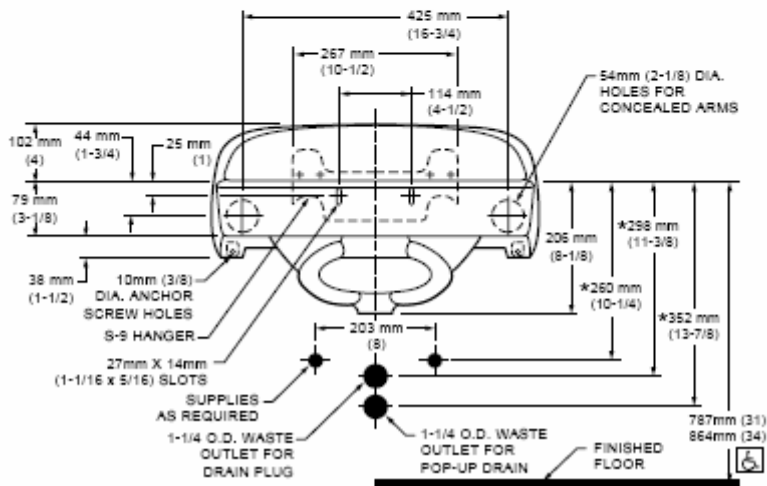
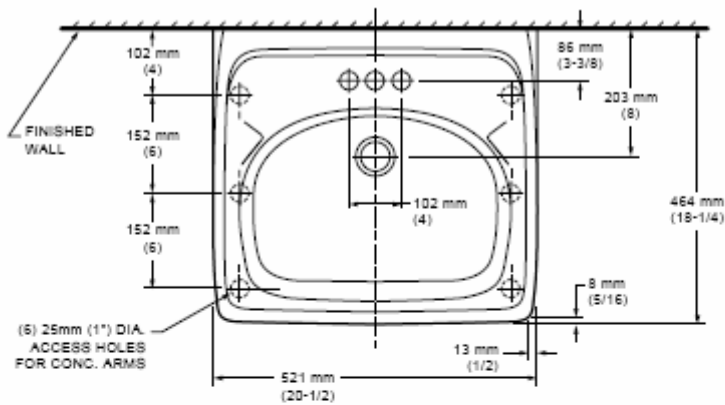

Wall Hung Lavatory 0355.012020

- white (020)
- bone (021)

Standard-Plate Mirror w/Light

Optional-Medicine Cabinets

Horizon-Frameless Cabinets



Shown with optional top light bar.

Tri-View/Rectangle

- Steel construction
- 3-way view
- 2 fixed steel shelves
- Frameless beveled-edge glass mirror
- Concealed hinges
- Matching light fixture available

Horizon features the quiet elegance of beveled-edge design. A wide selection of tri-view and single-door models with optional matching light bars make this classic model a good fit for any size room or décor.

Surface Mount Cabinets:

- Model: 255224 Overall Size: 24 x 24 x 5¼
- Model: 255230 Overall Size: 30 x 28¼ x 5¼
- Model: 255236 Overall Size: 36 x 28¼ x 5¼
- Model: 255248 Overall Size: 48 x 28¼ x 5¼

Recessed Mount Cabinets:

- Model: 255024 Overall Size: 24 x 24
- Wall Opening: 21¾ x 20¾ x 3½

- Model: 255030 Overall Size: 30 x 28¼
- Wall Opening: 37¾ x 24¾ x 3½

- Model: 255036 Overall Size: 36 x 28¼
- Wall Opening: 33¾ x 24¾ x 3½

- Model: 255048 Overall Size: 48 x 28¼
- Wall Opening: 45¾ x 24¾ x 3½

****Medicine Cabinets are also available with Hickory, Maple, Cherry, or Oak Merillat wood frames.**

Kerrico Marble Vanity Tops

Standard Colors:



White/White



Bone/White



Sterling Silver/White



Innocent Blush/White

Color Sample N/A
Solid White

Color Sample N/A
Solid Bone

Upgraded Granite Colors:



Ecru Granite

Color Sample N/A

**English Brown
Granite**



Sand Granite

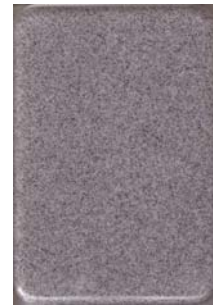

**Steel Gray
Granite**

Broan Bath Fan/Lights



70 CFM
Model #679



100CFM
Model #696

Standard Toilets



Elongated White

OP43492 135A

Contemporary Design with Color-Match Trip Lever
1.6 Gpf / 6.0 Lpf
2" Glazed Trapway
Large 8" x 9" Water Surface
Superior Boxed Rim, Siphon Jet Flushing Technology



Round White

OP43492 130A

Contemporary Design
Round Front
1.6 Gpf / 6.0 Lpf
Glazed Trapway
12" Rough-In
Large Water Surface Area
Superior Boxed Rim, Siphon Jet Flushing SmartFlush™ Technology

Effective upon usage of materials in stock, our toilet assemblies will be outfitted with a color-matched lever, flexible line and a chrome shut-off. This guideline will be followed irrespective of any specific hardware finish on the order.

Floor Mounted Laundry Sink

Single Compartment



Features

Floor Mounted Poly Tub:

Model P-1 Single basin poly tub shall be furnished with and supported by white baked enamel steel angle legs that slip into molded sockets for rigid friction fit. Legs are supplied with leveling devices. Unit comes with 4" or 8" faucet knockout (field installed).

Model P-1: 24" x 20" x 15 3/4" outside and inside compartment dimensions of 19" x 17 1/2" x 14 1/2".

Top View:

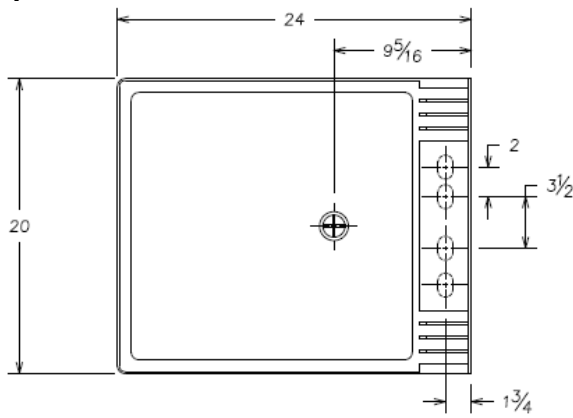

Front View:

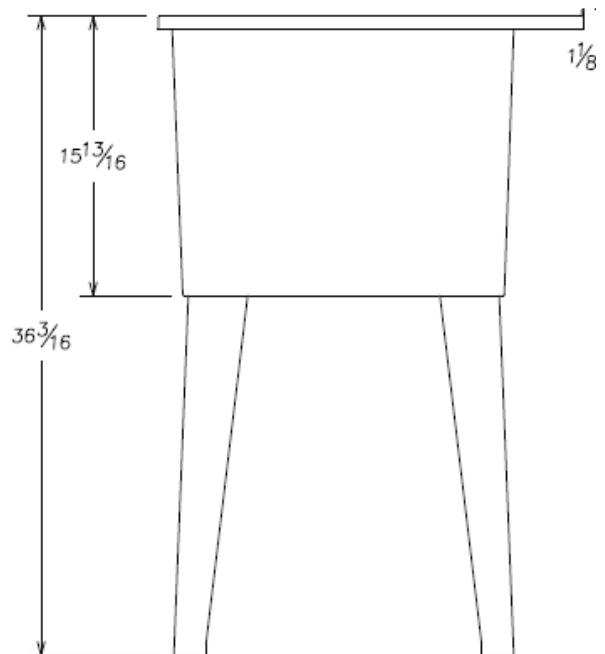

Ironing Center (optional)



Ironing Board: All metal construction - Durable, provides years of long standing use Ventilated metal board - Resistant to moisture and cools quickly

Storage: Hot iron storage shelf- Deep and tall to accommodate today's larger sized irons Additional storage shelf - Ability to store spray bottles, starch, other items in cabinet

Wall Installation Choices: Recess mount - Provides stream-lined, "built-in" appearance Surface mount (collar required) - Easy to mount, no hole to cut in wall (collar sold separately)

Hardware: Magnetic catch - Keeps door closed and neatly in place, door hinges (for left or right mounting) - Provides flexibility for your specific installation

Available With or Without Doors: Choice of simulated oak or white, included - Provides a complete unit, no need to buy separate door (choice of two finishes)

AVD40KN- Oak Door

AVD40WN-White Door

Water Heaters

PROLINE[®]



american
WATER HEATERS

RESIDENTIAL ELECTRIC

6-Year Tank Warranty

6-Year Parts Warranty

- **Fused Ceramic Shield**

A tough, thick durable coat of blue cobalt ceramic is fused to the tank's interior surfaces at 1600°F, forming a corrosion-resistant lining for years of dependable protection and use.

- **Dual Heating Elements**

Screw-in, direct immersion, 4500-watt, 240-volt heating elements for maximum efficiency. Available in multiple wattages and voltages for every job.

- **Non-CFC Foam Insulation**

The tank is surrounded by a thick coat of non-CFC polyurethane foam to trap heat inside the tank, saving energy.

- **Dip Tube**

Carries cold inlet water deep into the tank to minimize temperature dilution of hot water.

- **T&P Valve**

Conveniently located on the side of the tank to facilitate piping to a drain or external to the building. Also available with top T&P opening for field-installed top T&P valve.

- **3/4" Water Connections**

Located on top.

- **Anode Rod**

Top-mounted, heavy-duty anode for added tank protection, extending the life of the tank.

- **Built-In Electric Junction Box**

Top-located, convenient junction box, ready for 1/2" or 3/4" conduit.

- **Thermostat/High Limit Control**

Combination control allows adjustment of water temperature while preventing overheat protection.

- **Code Approvals**

Listed to UL 174, 1987 NAECA 2004 requirement, BOCA and ASHRAE 90.1-1999. All models are certified at 300 PSI test pressure and 150 PSI working pressure.

- **Drain Valve**

Child-resistant, corrosion-resistant drain valve.



MADE IN USA 

6-Year Limited Tank Warranty

Heavy gauge steel is automatically formed, rolled and welded to assure continuous seams for Fused Ceramic Shield lining. Each tank is triple tested to ensure quality.

6-Year Parts Warranty

Original factory parts warranted for 6 years.

40 Gal. Electric (gas option available) E61-40R-045

50 Gal. Electric (gas option available) E61-50R-045

46.5 Gal. Electric Lowboy (gas option not available) **Ideal for small spaces, closets etc.
E61-50L-045DV

80 Gal. Electric (gas option available)**Highly recommended if a whirlpool tub is installed.
E62-80R-45D

Warranty Information:

Hallmark Modular Homes warrants its product for one (1) year (from the date of delivery) from concealed structural damages or defects. Hallmark Modular Homes also enrolls every house in a ten (10) year limited warranty program with 2-10 Home Buyers Warranty. There will be an information packet forwarded to the homeowner. The information contained in this packet instructs the homeowner on what is an allowable claim. The information packet will also contain a list of industry-accepted tolerances on items throughout the home and how to submit a claim to the Home Buyers Warranty.

****All appliances and fixtures supplied by Hallmark Modular Homes are covered by their own individual manufacturer's warranties.**

Reminder to Builders:

Hallmark Modular Homes manufactures its homes to meet rigid specifications, including the BOCA, CABO and the standard state building codes when applicable. Although we design our products to meet most local building codes, due to circumstances beyond our control we cannot guarantee that we meet all local code requirements. For specifics, the builder should refer to his local building inspector and to Hallmark Modular Homes complete specifications.

****It is the builders responsibility to inform Hallmark Modular Homes in writing of any special requirements needed in their local area.**

NOTICE: The preceding Product Guide discloses our material Vendors/Manufacturers and their products. Any items are subject to change or substitution based on what is available at the actual time you order your home. In the production of our homes we use different grades of their products depending on which specification level you choose. You may of course make your own choices regardless of specifications at an appropriate adjustment to the price. We do understand that these Vendors offer many other products and we have given you links to their web sites so that you can browse other options. In the production of our modular products we use only those products tat are readily available through the distribution network (Suppliers) authorized by the Vendors to sell their products. Other products, though available from the Vendor, may take extended lead times and custom pricing. If you choose to use a product not list don our guide we suggest that you delete that item from the modular order and obtain the product through you local sources and install same in your home once delivered. Often products listed by Vendors are no longer available or the lead times are longer than the normal “construction” time of you home. Also, local Suppliers representing a particular Vendor may not carry the Vendor’s entire product line. As stated above, special order items may delay your house, cost more and not have the same warrantee as the standard available products. Thank you for your valuable consideration. We are here to make your modular purchasing experience with Hallmark as professional and rewarding as possible.

Contact Information:

Hallmark Modular Homes

P.O. Box 1810

Charlestown, RI 02813

Phone: 401-364-0400

Fax: 401-364-3435

Web site: <http://www.hallmarkmodularhomes.com>